

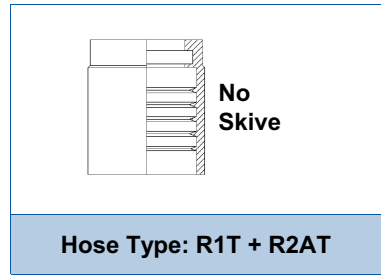

Crimp Ferrules for Hydraulic Hose Fittings

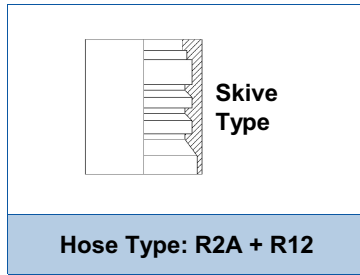

Hose I.D.	Hose Type: R1A	Hose Type: R2A + R12	Hose Type: R1T + R2AT
3/16"	PF-1-03	PF-2-03	PF-1T/2T-03
1/4"	PF-1-04	PF-2-04	PF-1T/2T-04
5/16"	PF-1-05	PF-2-05	PF-1T/2T-05
3/8"	PF-1-06	PF-2-06	PF-1T/2T-06
1/2"	PF-1-08	PF-2-08	PF-1T/2T-08
5/8"	PF-1-10	PF-2-10	PF-1T/2T-10
3/4"	PF-1-12	PF-2-12	PF-1T/2T-12
1"	PF-1-16	PF-2-16	PF-1T/2T-16
1-1/4"	PF-1-20	PF-2-20	PF-1T/2T-20
1-1/2"	PF-1-24	PF-2-24	PF-1T/2T-24
2"	PF-1-32	PF-2-32	PF-1T/2T-32

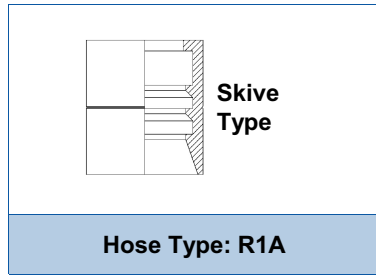
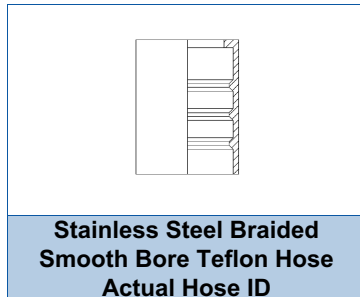
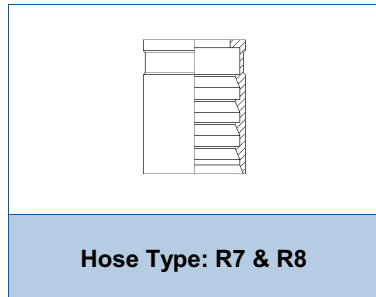

Hose I.D.	Hose Type: R7 & R8	Stainless Steel Braided Smooth Bore Teflon Hose Actual Hose ID	Stainless Steel Braided Convoluted Teflon Hose
3/16"	PF-7-03		
1/4"	PF-7-04	PTTB-04	PTTC-04
5/16"	PF-7-05		
3/8"	PF-7-06	PTTB-06	PTTC-06
1/2"	PF-7-08	PTTB-08	PTTC-08
5/8"	PF-7-10	PTTB-10	PTTC-10
3/4"	PF-7-12	PTTB-12	PTTC-12
1"	PF-7-16	PTTB-16	PTTC-16
1-1/4"			PTTC-20
1-1/2"			PTTC-24
2"			PTTC-32

All ferrules must be crimped full length, preferably with an 8-finger crimper. Crimp specifications available.



British Standard Pipe (BSP) Hose Fittings

Hose I.D.	BSP Size	Thread Size	BSPP Male 60° Cone	BSPP Male Flat Seat	BSPT Male Tapered
1/8	1/8	1/8 – 28	AGR-02-02		
1/8	1/4	1/4 – 19	AGR-02-04		
3/16	1/8	1/8 – 28	AGR-03-02		AGR-K-03-02
3/16	1/4	1/4 – 19	AGR-03-04		
1/4	1/8	1/8 – 28	AGR-04-02		AGR-K-04-02
1/4	1/4	1/4 – 19	AGR-04-04	AGR-F-04-04	AGR-K-04-04
1/4	3/8	3/8 – 19	AGR-04-06		AGR-K-04-06
5/16	3/8	3/8 – 19	AGR-05-06	AGR-F-05-06	AGR-K-05-06
3/8	1/4	1/4 – 19	AGR-06-04		AGR-K-06-04
3/8	3/8	3/8 – 19	AGR-06-06	AGR-F-06-06	AGR-K-06-06
3/8	1/2	1/2 – 14	AGR-06-08	AGR-F-06-08	AGR-K-06-08
1/2	3/8	3/8 – 19	AGR-08-06		
1/2	1/2	1/2 – 14	AGR-08-08	AGR-F-08-08	AGR-K-08-08
1/2	5/8	5/8 – 14	AGR-08-10		AGR-K-08-10
1/2	3/4	3/4 – 14	AGR-08-12		
5/8	5/8	5/8 – 14	AGR-10-10	AGR-F-10-10	AGR-K-10-10
5/8	3/4	3/4 – 14	AGR-10-12		AGR-K-10-12
3/4	3/4	3/4 – 14	AGR-12-12	AGR-F-12-12	AGR-K-12-12
3/4	1"	1 – 11	AGR-12-16	AGR-F-12-16	AGR-K-12-16
1"	1"	1 – 11	AGR-16-16	AGR-F-16-16	AGR-K-16-16
1"	1-1/4	1 1/4 – 11	AGR-16-20	AGR-F-16-20	AGR-K-16-20
1-1/4	1-1/4	1 1/4 – 11	AGR-20-20	AGR-F-20-20	AGR-K-20-20
1-1/4	1-1/2	1 1/2 – 11	AGR-20-24		AGR-K-20-24
1-1/2	1-1/2	1 1/2 – 11	AGR-24-24	AGR-F-24-24	AGR-K-24-24
2"	2"	2 – 11	AGR-32-32	AGR-F-32-32	AGR-K-32-32

BSP parallel threads may be used in ports (with appropriate seals) or in BSP female swivel connections (sealing on the 60° cone).

The flat seat BSPP fittings are most often seen on HIAB cranes.

BSP Taper threads can also be used in applications requiring Japanese (JIS) male threads.



British Standard Pipe (BSP) Hose Fittings

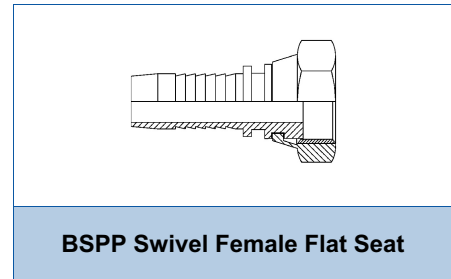
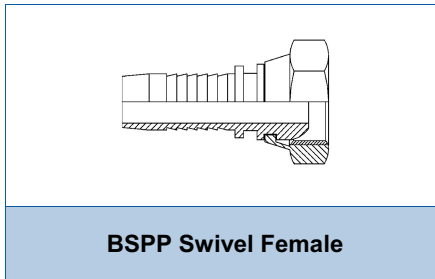

Hose I.D.	BSP Size	Thread Size	BSPP Swivel Female	BSPP Swivel Female Flat Seat
1/8	1/8	1/8 – 28	DKR-02-02	
1/8	1/4	1/4 – 19	DKR-02-04	
3/16	1/8	1/8 – 28	DKR-03-02	
3/16	1/4	1/4 – 19	DKR-03-04	
1/4	1/8	1/8 – 28	DKR-04-02	
1/4	1/4	1/4 – 19	DKR-04-04	DKR-F-04-04
1/4	3/8	3/8 – 19	DKR-04-06	DKR-F-04-06
1/4	1/2	1/2 – 14	DKR-04-08	DKR-F-04-08
5/16	1/4	1/4 – 19	DKR-05-04	
5/16	3/8	3/8 – 19	DKR-05-06	DKR-F-05-06
3/8	1/4	1/4 – 19	DKR-06-04	
3/8	3/8	3/8 – 19	DKR-06-06	DKR-F-06-06
3/8	1/2	1/2 – 14	DKR-06-08	DKR-F-06-08
1/2	3/8	3/8 – 19	DKR-08-06	DKR-F-08-06
1/2	1/2	1/2 – 14	DKR-08-08	DKR-F-08-08
1/2	5/8	5/8 – 14	DKR-08-10	
1/2	3/4	3/4 – 14	DKR-08-12	DKR-F-08-12
5/8	1/2	1/2 – 14	DKR-10-08	
5/8	5/8	5/8 – 14	DKR-10-10	
5/8	3/4	3/4 – 14	DKR-10-12	DKR-F-10-12
3/4	3/4	3/4 – 14	DKR-12-12	DKR-F-12-12
3/4	1"	1 – 11	DKR-12-16	
1"	1"	1 – 11	DKR-16-16	DKR-F-16-16
1"	1-1/4	1 1/4 – 11	• DKR-16-20	
1-1/4	1-1/4	1 1/4 – 11	• DKR-20-20	DKR-F-20-20
1-1/4	1-1/2	1 1/2 – 11	• DKR-20-24	
1-1/2	1-1/2	1 1/2 – 11	• DKR-24-24	DKR-F-24-24
1-1/2	2"	2 – 11	• DKR-24-32	
2"	2"	2 – 11	• DKR-32-32	DKR-F-32-32

• Sizes 1-1/4" BSP and above will only be available with o-ring seal (See DKOR- fittings).

Williams Fluidair Corporation Limited

1018 Salk Road Pickering, Ontario Canada L1W 3C5

T: 905-831-3222 F: 905-831-3284 E: service@williamsfluidair.com W: www.williamsfluidair.com

Hose Fittings

Page 3 of 49



British Standard Pipe (BSP) Hose Fittings

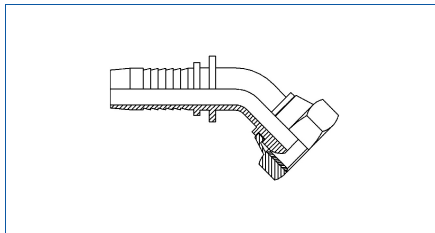

BSPP Swivel Female 45° Elbow

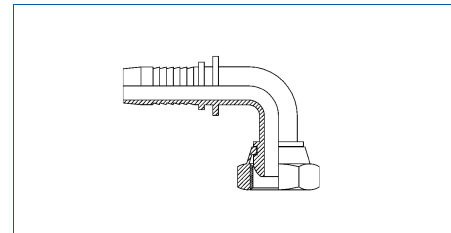

BSPP Swivel Female 90° Elbow

Hose I.D.	BSP Size	Thread Size
3/16	1/8	1/8 – 28
3/16	1/4	1/4 – 19
1/4	1/8	1/8 – 28
1/4	1/4	1/4 – 19
1/4	3/8	3/8 – 19
1/4	1/2	1/2 – 14
5/16	3/8	3/8 – 19
3/8	3/8	3/8 – 19
3/8	1/2	1/2 – 14
1/2	1/2	1/2 – 14
1/2	5/8	5/8 – 14
1/2	3/4	3/4 – 14
5/8	1/2	1/2 – 14
5/8	5/8	5/8 – 14
5/8	3/4	3/4 – 14
3/4	3/4	3/4 – 14
3/4	1"	1 – 11
1"	1"	1 – 11
1"	1-1/4	1 1/4 – 11
1-1/4	1-1/4	1 1/4 – 11
1-1/4	1-1/2	1 1/2 – 11
1-1/2	1-1/2	1 1/2 – 11
1-1/2	2"	2 – 11
2"	2"	2 – 11

DKR-45-03-02
DKR-45-03-04
DKR-45-04-02
DKR-45-04-04
DKR-45-04-06
DKR-45-04-08
DKR-45-05-06
DKR-45-06-06
DKR-45-06-08
DKR-45-08-08
DKR-45-08-10
DKR-45-08-12
DKR-45-10-08
DKR-45-10-10
DKR-45-10-12
DKR-45-12-12
DKR-45-12-16
DKR-45-16-16
● DKR-45-16-20
● DKR-45-20-20
● DKR-45-20-24
● DKR-45-24-24
● DKR-45-24-32
● DKR-45-32-32

DKR-90-03-02
DKR-90-03-04
DKR-90-04-02
DKR-90-04-04
DKR-90-04-06
DKR-90-04-08
DKR-90-05-06
DKR-90-06-06
DKR-90-06-08
DKR-90-08-08
DKR-90-08-10
DKR-90-08-12
DKR-90-10-08
DKR-90-10-10
DKR-90-10-12
DKR-90-12-12
DKR-90-12-16
DKR-90-16-16
● DKR-90-16-20
● DKR-90-20-20
● DKR-90-20-24
● DKR-90-24-24
● DKR-90-24-32
● DKR-90-32-32

● Sizes 1-1/4" BSP and above will only be available with o-ring seal (See DKOR- fittings).



BSP Female Swivel O-Ring Hose Fittings

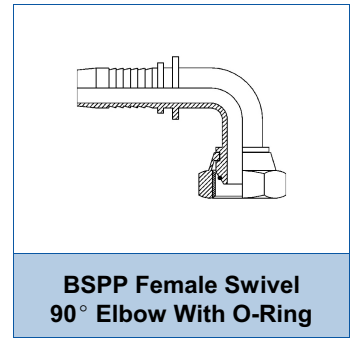
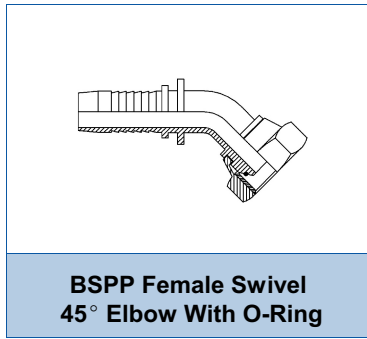
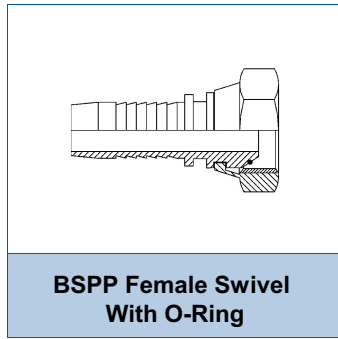

Hose I.D.	BSP Size	BSPP Female Swivel With O-Ring	BSPP Female Swivel 45° Elbow With O-Ring	BSPP Female Swivel 90° Elbow With O-Ring
1/4	1/4	DKOR-04-04	DKOR-45-04-04	DKOR-90-04-04
3/8	3/8	DKOR-06-06	DKOR-45-06-06	DKOR-90-06-06
1/2	1/2	DKOR-08-08	DKOR-45-08-08	DKOR-90-08-08
5/8	5/8	DKOR-10-10	DKOR-45-10-10	DKOR-90-10-10
3/4	3/4	DKOR-12-12	DKOR-45-12-12	DKOR-90-12-12
1"	1"	DKOR-16-16	DKOR-45-16-16	DKOR-90-16-16
1"	1-1/4	DKOR-16-20	DKOR-45-16-20	DKOR-90-16-20
1-1/4	1-1/4	DKOR-20-20	DKOR-45-20-20	DKOR-90-20-20
1-1/4	1-1/2	DKOR-20-24	DKOR-45-20-24	DKOR-90-20-24
1-1/2	1-1/2	DKOR-24-24	DKOR-45-24-24	DKOR-90-24-24
1-1/2	2"	DKOR-24-32	DKOR-45-24-32	DKOR-90-24-32
2"	2"	DKOR-32-32	DKOR-45-32-32	DKOR-90-32-32



Metric Standpipe Hose Fittings

Hose I.D.	Standpipe Size	Metric Standpipe Straight	Metric Standpipe 45° Elbow	Metric Standpipe 90° Elbow
3/16	6mm	BEM-03-06	BEM-45-03-06	BEM-90-03-06
3/16	8mm	BEM-03-08	BEM-45-03-08	BEM-90-03-08
1/4	6mm	BEM-04-06	BEM-45-04-06	BEM-90-04-06
1/4	8mm	BEM-04-08	BEM-45-04-08	BEM-90-04-08
1/4	10mm	BEM-04-10	BEM-45-04-10	BEM-90-04-10
1/4	12mm	BEM-04-12	BEM-45-04-12	BEM-90-04-12
5/16	8mm	BEM-05-08	BEM-45-05-08	BEM-90-05-08
5/16	10mm	BEM-05-10	BEM-45-05-10	BEM-90-05-10
5/16	12mm	BEM-05-12	BEM-45-05-12	BEM-90-05-12
3/8	10mm	BEM-06-10	BEM-45-06-10	BEM-90-06-10
3/8	12mm	BEM-06-12	BEM-45-06-12	BEM-90-06-12
3/8	14mm	BEM-06-14	BEM-45-06-14	BEM-90-06-14
3/8	15mm	BEM-06-15	BEM-45-06-15	BEM-90-06-15
1/2	14mm	BEM-08-14	BEM-45-08-14	BEM-90-08-14
1/2	15mm	BEM-08-15	BEM-45-08-15	BEM-90-08-15
1/2	16mm	BEM-08-16	BEM-45-08-16	BEM-90-08-16
1/2	18mm	BEM-08-18	BEM-45-08-18	BEM-90-08-18
5/8	18mm	BEM-10-18	BEM-45-10-18	BEM-90-10-18
5/8	20mm	BEM-10-20	BEM-45-10-20	BEM-90-10-20
3/4	20mm	BEM-12-20	BEM-45-12-20	BEM-90-12-20
3/4	22mm	BEM-12-22	BEM-45-12-22	BEM-90-12-22
3/4	25mm	BEM-12-25	BEM-45-12-25	BEM-90-12-25
1"	28mm	BEM-16-28	BEM-45-16-28	BEM-90-16-28
1"	30mm	BEM-16-30	BEM-45-16-30	BEM-90-16-30
1-1/4	35mm	BEM-20-35	BEM-45-20-35	BEM-90-20-35
1-1/4	38mm	BEM-20-38	BEM-45-20-38	BEM-90-20-38
1-1/2	42mm	BEM-24-42	BEM-45-24-42	BEM-90-24-42

Stand pipes are most often used to connect hose to DIN 2353 tube fittings.

This is a convenient way to combine hose and tubing in an installation.

For spiral hose applications, use the DKOL- and DKOS- hose ends.



Metric Hose Fittings for DIN 2353 Tube Fittings (L Series, 24° Cone)

Hose I.D.	Tube Size	Thread Size
1/4	8-L	M14x1.5
5/16	10-L	M16x1.5
3/8	10-L	M16x1.5
3/8	12-L	M18x1.5
1/2	15-L	M22x1.5
5/8	18-L	M26x1.5
3/4	22-L	M30x2
1"	28-L	M36x2
1-1/4	35-L	M45x2
1-1/2	42-L	M52x2

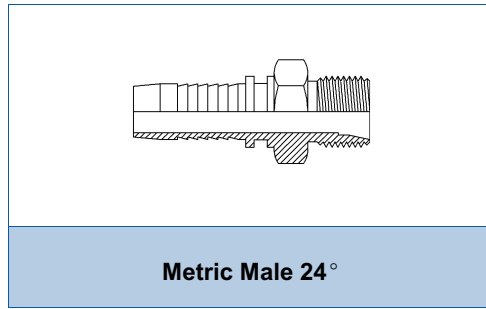

CEL-04-14
CEL-05-16
CEL-06-16
CEL-06-18
CEL-08-22
CEL-10-26
CEL-12-30
CEL-16-36
CEL-20-45
CEL-24-52

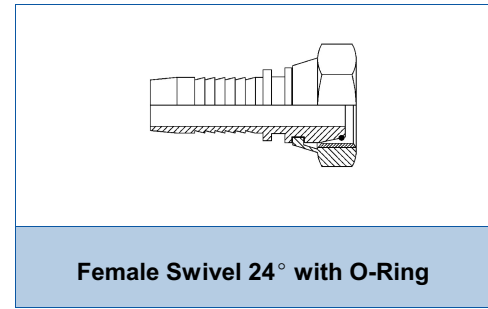

DKOL-04-14
DKOL-05-16
DKOL-06-16
DKOL-06-18
DKOL-08-22
DKOL-10-26
DKOL-12-30
DKOL-16-36
DKOL-20-45
DKOL-24-52

Hose I.D.	Tube Size	Thread Size
1/4	8-L	M14x1.5
5/16	10-L	M16x1.5
3/8	10-L	M16x1.5
3/8	12-L	M18x1.5
1/2	15-L	M22x1.5
5/8	18-L	M26x1.5
3/4	22-L	M30x2
1"	28-L	M36x2
1-1/4	35-L	M45x2
1-1/2	42-L	M52x2

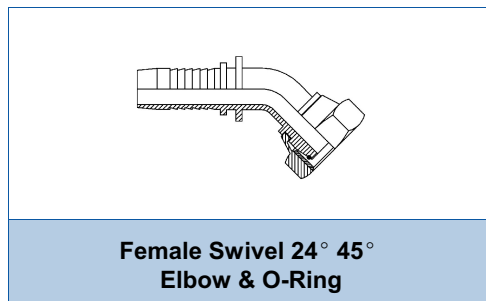

DKOL-45-04-14
DKOL-45-05-16
DKOL-45-06-16
DKOL-45-06-18
DKOL-45-08-22
DKOL-45-10-26
DKOL-45-12-30
DKOL-45-16-36
DKOL-45-20-45
DKOL-45-24-52

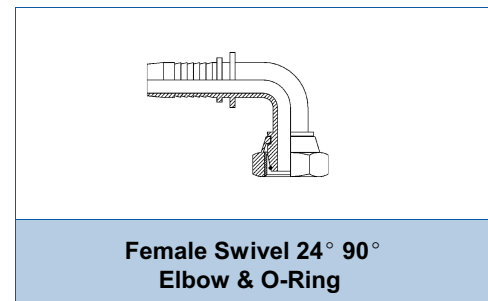

DKOL-90-04-14
DKOL-90-05-16
DKOL-90-06-16
DKOL-90-06-18
DKOL-90-08-22
DKOL-90-10-26
DKOL-90-12-30
DKOL-90-16-36
DKOL-90-20-45
DKOL-90-24-52



Metric Hose Fittings for DIN 2353 Tube Fittings (S Series, 24° Cone)

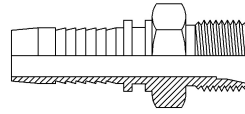

Metric Male 24°

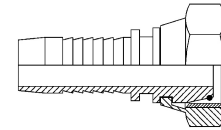

Female Swivel 24° with O-Ring

Hose I.D.	Tube Size	Thread Size
1/4	10-S	M18x1.5
5/16	12-S	M20x1.5
3/8	12-S	M20x1.5
3/8	14-S	M22x1.5
1/2	16-S	M24x1.5
5/8	20-S	M30x2
3/4	25-S	M36x2
1"	30-S	M42x2
1-1/4	38-S	M52x2

CES-04-18
CES-05-20
CES-06-20
CES-06-22
CES-08-24
CES-10-30
CES-12-36
CES-16-42
CES-20-52

DKOS-04-18
DKOS-05-20
DKOS-06-20
DKOS-06-22
DKOS-08-24
DKOS-10-30
DKOS-12-36
DKOS-16-42
DKOS-20-52

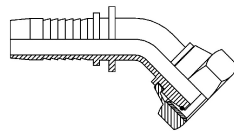

Female Swivel 24° 45° Elbow & O-Ring

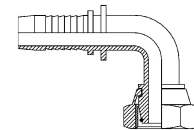

Female Swivel 24° 90° Elbow & O-Ring

Hose I.D.	Tube Size	Thread Size
1/4	10-S	M18x1.5
5/16	12-S	M20x1.5
3/8	12-S	M20x1.5
3/8	14-S	M22x1.5
1/2	16-S	M24x1.5
5/8	20-S	M30x2
3/4	25-S	M36x2
1"	30-S	M42x2
1-1/4	38-S	M52x2

DKOS-45-04-18
DKOS-45-05-20
DKOS-45-06-20
DKOS-45-06-22
DKOS-45-08-24
DKOS-45-10-30
DKOS-45-12-36
DKOS-45-16-42
DKOS-45-20-52

DKOS-90-04-18
DKOS-90-05-20
DKOS-90-06-20
DKOS-90-06-22
DKOS-90-08-24
DKOS-90-10-30
DKOS-90-12-36
DKOS-90-16-42
DKOS-90-20-52



Metric Hose Fittings 60° / 24° Cone Seat

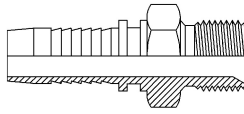

Metric Male 60° Cone

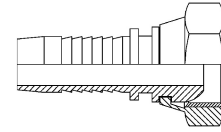

Metric Female Swivel

Hose I.D.	Thread Size	Metric Male 60° Cone	Metric Female Swivel
3/16	M10x1	AGM-03-10	DKM-03-10
1/4	M12X1.5	AGM-04-12	DKM-04-12
1/4	M14X1.5	AGM-04-14	DKM-04-14
5/16	M16X1.5	AGM-05-16	DKM-05-16
5/16	M18X1.5	AGM-05-18	DKM-05-18
3/8	M16X1.5	AGM-06-16	DKM-06-16
3/8	M18X1.5	AGM-06-18	DKM-06-18
3/8	M22X1.5	AGM-06-22	DKM-06-22
1/2	M18X1.5	AGM-08-18	DKM-08-18
1/2	M20X1.5	AGM-08-20	DKM-08-20
1/2	M22X1.5	AGM-08-22	DKM-08-22
5/8	M26X1.5	AGM-10-26	DKM-10-26
3/4	M26X1.5	AGM-12-26	DKM-12-26
3/4	M30X1.5	AGM-12-30	DKM-12-30
1"	M38X1.5	AGM-16-38	DKM-16-38
1-1/4	M45X1.5	AGM-20-45	DKM-20-45
1-1/2	M52X1.5	AGM-24-52	DKM-24-52
2"	M65X2	AGM-32-65	DKM-32-65

Notes:

1. AGM- hose ends may be used as a port fitting (using an appropriate seal) or may connect to a female swivel fitting with a 60° cone seat.
2. The female swivel fittings (DKM-, DKM-45-, and DKM-90-) may also be used to connect to DIN 2353-L tube fittings with the corresponding thread size. This only applies up to thread size M26x1.5 (18-L tube size).



Metric Hose Fittings 60° / 24° Cone Seat

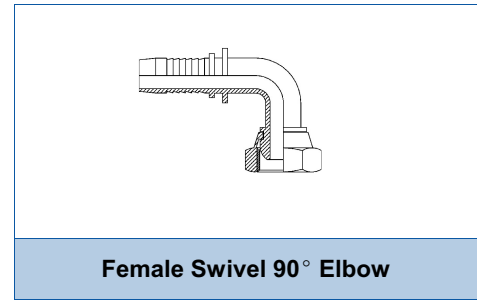
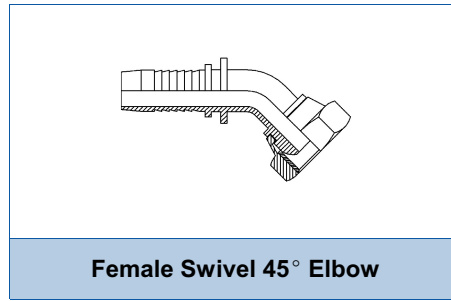

Hose I.D.	Thread Size	Female Swivel 45° Elbow	Female Swivel 90° Elbow
3/16	M10x1	DKM-45-03-10	DKM-90-03-10
1/4	M12X1.5	DKM-45-04-12	DKM-90-04-12
1/4	M14X1.5	DKM-45-04-14	DKM-90-04-14
5/16	M16X1.5	DKM-45-05-16	DKM-90-05-16
5/16	M18X1.5	DKM-45-05-18	DKM-90-05-18
3/8	M16X1.5	DKM-45-06-16	DKM-90-06-16
3/8	M18X1.5	DKM-45-06-18	DKM-90-06-18
3/8	M22X1.5	DKM-45-06-22	DKM-90-06-22
1/2	M18X1.5	DKM-45-08-18	DKM-90-08-18
1/2	M20X1.5	DKM-45-08-20	DKM-90-08-20
1/2	M22X1.5	DKM-45-08-22	DKM-90-08-22
5/8	M26X1.5	DKM-45-10-26	DKM-90-10-26
3/4	M26X1.5	DKM-45-12-26	DKM-90-12-26
3/4	M30X1.5	DKM-45-12-30	DKM-90-12-30
1"	M38X1.5	DKM-45-16-38	DKM-90-16-38
1-1/4	M45X1.5	DKM-45-20-45	DKM-90-20-45
1-1/2	M52X1.5	DKM-45-24-52	DKM-90-24-52
2"	M65X2	DKM-45-32-65	DKM-90-32-65

Notes:

1. AGM- hose ends may be used as a port fitting (using an appropriate seal) or may connect to a female swivel fitting with a 60° cone seat.
2. The female swivel fittings (DKM-, DKM-45-, and DKM-90-) may also be used to connect to DIN 2353-L tube fittings with the corresponding thread size. This only applies up to thread size M26x1.5 (18-L tube size).

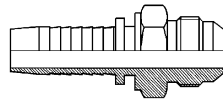

Male JIC

Part Number

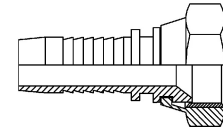

Female JIC

Part Number

Hose Size	Hose I.D.	JIC Dash Size	Thread Size
-3	3/16"	-4	7/16 – 20
-4	1/4"	-4	7/16 – 20
-4	1/4"	-5	1/2 – 20
-4	1/4"	-6	9/16 – 18
-4	1/4"	-8	3/4 – 16
-5	5/16"	-5	1/2 – 20
-5	5/16"	-6	9/16 – 18
-6	3/8"	-6	9/16 – 18
-6	3/8"	-8	3/4 – 16
-6	3/8"	-10	7/8 – 14
-8	1/2"	-8	3/4 – 16
-8	1/2"	-10	7/8 – 14
-8	1/2"	-12	1 ¹ / ₁₆ – 12
-10	5/8"	-10	7/8 – 14
-10	5/8"	-12	1 ¹ / ₁₆ – 12
-12	3/4"	-12	1 ¹ / ₁₆ – 12
-12	3/4"	-16	1 ⁵ / ₁₆ – 12
-16	1"	-12	1 ¹ / ₁₆ – 12
-16	1"	-16	1 ⁵ / ₁₆ – 12
-16	1"	-20	1 ⁵ / ₈ – 12
-20	1-1/4"	-20	1 ⁵ / ₈ – 12
-24	1-1/2"	-24	1 ⁷ / ₈ – 12
-32	2"	-32	2 ¹ / ₂ – 12

AGJ-04-04
AGJ-04-05
AGJ-04-06
AGJ-04-08
AGJ-05-05
AGJ-05-06
AGJ-06-06
AGJ-06-08
AGJ-06-10
AGJ-08-08
AGJ-08-10
AGJ-10-10
AGJ-10-12
AGJ-12-12
AGJ-12-16
AGJ-16-12
AGJ-16-16
AGJ-16-20
AGJ-20-20
AGJ-24-24
AGJ-32-32

DKJ-03-04
DKJ-04-04
DKJ-04-05
DKJ-04-06
DKJ-05-05
DKJ-05-06
DKJ-06-06
DKJ-06-08
DKJ-06-10
DKJ-08-08
DKJ-08-10
DKJ-08-12
DKJ-10-10
DKJ-10-12
DKJ-12-12
DKJ-12-16
DKJ-16-12
DKJ-16-16
DKJ-16-20
DKJ-20-20
DKJ-24-24
DKJ-32-32

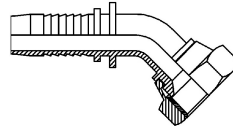

Female JIC 45°

Part Number

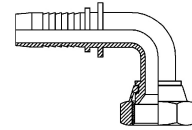

Female JIC 90°

Part Number

Hose Size	Hose I.D.	JIC Dash Size	Thread Size
-3	3/16"	-4	7/16 – 20
-4	1/4"	-4	7/16 – 20
-4	1/4"	-5	1/2 – 20
-4	1/4"	-6	9/16 – 18
-5	5/16"	-5	1/2 – 20
-5	5/16"	-6	9/16 – 18
-6	3/8"	-6	9/16 – 18
-6	3/8"	-8	3/4 – 16
-6	3/8"	-10	7/8 – 14
-8	1/2"	-8	3/4 – 16
-8	1/2"	-10	7/8 – 14
-10	5/8"	-10	7/8 – 14
-10	5/8"	-12	1 ¹ / ₁₆ – 12
-12	3/4"	-12	1 ¹ / ₁₆ – 12
-12	3/4"	-16	1 ⁵ / ₁₆ – 12
-16	1"	-16	1 ⁵ / ₁₆ – 12
-16	1"	-20	1 ⁵ / ₈ – 12
-20	1-1/4"	-20	1 ⁵ / ₈ – 12
-20	1-1/4"	-24	1 ⁷ / ₈ – 12
-24	1-1/2"	-24	1 ⁷ / ₈ – 12
-32	2"	-32	2 ¹ / ₂ – 12

DKJ-45-03-04

DKJ-45-04-04

DKJ-45-04-05

DKJ-45-04-06

DKJ-45-05-05

DKJ-45-05-06

DKJ-45-06-06

DKJ-45-06-08

DKJ-45-06-10

DKJ-45-08-08

DKJ-45-08-10

DKJ-45-10-10

DKJ-45-10-12

DKJ-45-12-12

DKJ-45-12-16

DKJ-45-16-16

DKJ-45-16-20

DKJ-45-20-20

DKJ-45-20-24

DKJ-45-24-24

DKJ-45-32-32

DKJ-90-03-04

DKJ-90-04-04

DKJ-90-04-05

DKJ-90-04-06

DKJ-90-05-05

DKJ-90-05-06

DKJ-90-06-06

DKJ-90-06-08

DKJ-90-06-10

DKJ-90-08-08

DKJ-90-08-10

DKJ-90-10-10

DKJ-90-10-12

DKJ-90-12-12

DKJ-90-12-16

DKJ-90-16-16

DKJ-90-16-20

DKJ-90-20-20

DKJ-90-20-24

DKJ-90-24-24

DKJ-90-32-32

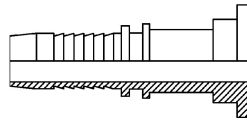

Code 61 Flange

Part Number

FL3-08-08
 FL3-08-12
 FL3-10-12
 FL3-12-12
 FL3-12-16
 FL3-16-16
 FL3-16-20
 FL3-20-20
 FL3-20-24
 FL3-24-24
 FL3-24-32
 FL3-32-32

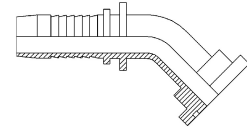

Code 61 Flange 45°

Part Number

FL3-45-08-08
 FL3-45-08-12
 FL3-45-10-12
 FL3-45-12-12
 FL3-45-12-16
 FL3-45-16-16
 FL3-45-16-20
 FL3-45-20-20
 FL3-45-20-24
 FL3-45-24-24
 FL3-45-24-32
 FL3-45-32-32

Hose Size	Hose I.D.	Flange Dash Size	Flange O.D.
-8	1/2"	-8	1.19"
-8	1/2"	-12	1.50"
-10	5/8"	-12	1.50"
-12	3/4"	-12	1.50"
-12	3/4"	-16	1.75"
-16	1"	-16	1.75"
-16	1"	-20	2.00"
-20	1-1/4"	-20	2.00"
-20	1-1/4"	-24	2.38"
-24	1-1/2"	-24	2.38"
-24	1-1/2"	-32	2.81"
-32	2"	-32	2.81"

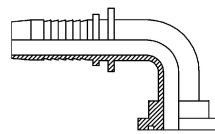

Code 61 Flange 90°

Part Number

FL3-90-08-08
 FL3-90-08-12
 FL3-90-10-12
 FL3-90-12-12
 FL3-90-12-16
 FL3-90-16-16
 FL3-90-16-20
 FL3-90-20-20
 FL3-90-20-24
 FL3-90-24-24
 FL3-90-24-32
 FL3-90-32-32

Hose Size	Hose I.D.	Flange Dash Size	Flange O.D.
-8	1/2"	-8	1.19"
-8	1/2"	-12	1.50"
-10	5/8"	-12	1.50"
-12	3/4"	-12	1.50"
-12	3/4"	-16	1.75"
-16	1"	-16	1.75"
-16	1"	-20	2.00"
-20	1-1/4"	-20	2.00"
-20	1-1/4"	-24	2.38"
-24	1-1/2"	-24	2.38"
-24	1-1/2"	-32	2.81"
-32	2"	-32	2.81"

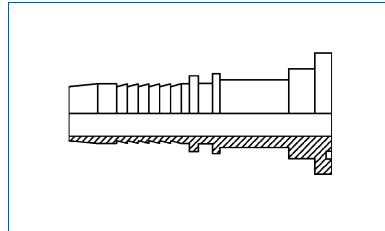

Code 62 Flange

Part Number

- FL6-08-08
- FL6-08-12
- FL6-10-12
- FL6-12-12
- FL6-12-16
- FL6-16-16
- FL6-16-20
- FL6-20-20
- FL6-20-24
- FL6-24-24
- FL6-24-32
- FL6-32-32

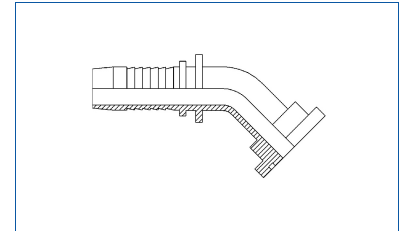

Code 62 Flange 45

Part Number

- FL6-45-08-08
- FL6-45-08-12
- FL6-45-10-12
- FL6-45-12-12
- FL6-45-12-16
- FL6-45-16-16
- FL6-45-16-20
- FL6-45-20-20
- FL6-45-20-24
- FL6-45-24-24
- FL6-45-24-32
- FL6-45-32-32

Hose Size	Hose I.D.	Flange Dash Size	Flange O.D.
-8	1/2"	-8	1.25"
-8	1/2"	-12	1.63"
-10	5/8"	-12	1.63"
-12	3/4"	-12	1.63"
-12	3/4"	-16	1.88"
-16	1"	-16	1.88"
-16	1"	-20	2.13"
-20	1-1/4"	-20	2.13"
-20	1-1/4"	-24	2.50"
-24	1-1/2"	-24	2.50"
-24	1-1/2"	-32	3.13"
-32	2"	-32	3.13"

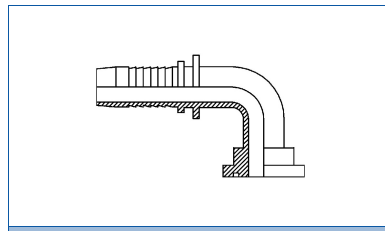

Code 62 Flange 90°

Part Number

- FL6-90-08-08
- FL6-90-08-12
- FL6-90-10-12
- FL6-90-12-12
- FL6-90-12-16
- FL6-90-16-16
- FL6-90-16-20
- FL6-90-20-20
- FL6-90-20-24
- FL6-90-24-24
- FL6-90-24-32
- FL6-90-32-32

Hose Size	Hose I.D.	Flange Dash Size	Flange O.D.
-8	1/2	-8	1.25"
-8	1/2	-12	1.63"
-10	5/8	-12	1.63"
-12	3/4	-12	1.63"
-12	3/4	-16	1.88"
-16	1"	-16	1.88"
-16	1"	-20	2.13"
-20	1-1/4	-20	2.13"
-20	1-1/4	-24	2.50"
-24	1-1/2	-24	2.50"
-24	1-1/2	-32	3.13"
-32	2"	-32	3.13"

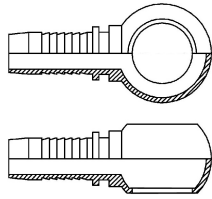

Banjo Hose Fitting

Hose Size	Banjo Bolt Size	Part Number
3/16	1/8" BSPP	RNR-03-02
1/4	1/8" BSPP	RNR-04-02
1/4	1/4" BSPP	RNR-04-04
1/4	3/8" BSPP	RNR-04-06
3/8	3/8" BSPP	RNR-06-06
3/8	1/2" BSPP	RNR-06-08
1/2	1/2" BSPP	RNR-08-08
3/4	3/4" BSPP	RNR-12-12
1"	1" BSPP	RNR-16-16
3/16	10mm	RNR-03-10
1/4	10mm	RNR-04-10
1/4	12mm	RNM-04-12
1/4	14mm	RNM-04-14
3/8	16mm	RNM-06-16
3/8	18mm	RNM-06-18
1/2	18mm	RNM-08-18
1/2	22mm	RNM-08-22
5/8	18mm	RNM-10-18
5/8	22mm	RNM-10-22
5/8	26mm	RNM-10-26
3/4	26mm	RNM-12-26
3/4	30mm	RNM-12-30
1"	33mm	RNM-16-33

Notes:

Additional metric sizes can be obtained by using the following BSPP sizes:

For 27mm use RNR-12-12

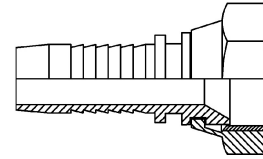

JIS Female Swivel - 30° Flare Seat

Hose Size	Thread Size	Part Number
1/4	1/4 - 19 BSP	DKR-J-04-04
3/8	3/8 - 19 BSP	DKR-J-06-06
1/2	1/2 - 14 BSP	DKR-J-08-08
3/4	3/4 - 14 BSP	DKR-J-12-12
1"	1 - 11 BSP	DKR-J-16-16
1-1/4	1 1/4 - 11 BSP	DKR-J-20-20
1/4	M14X1.5	DKM-J-04-14
1/4	M16X1.5	DKM-J-04-16
3/8	M18X1.5	DKM-J-06-18
1/2	M22X1.5	DKM-J-08-22
3/4	M26X1.5	DKM-J-12-26
1"	M30X1.5	DKM-J-16-30
1-1/4	M38X1.5	DKM-J-20-38

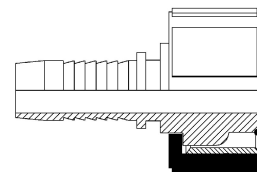

Pressure Washer

Hose Size	Thread Size	Part Number
1/4	M22 x 1.5	DKK-04-22
5/16	M22 x 1.5	DKK-05-22
3/8	M22 x 1.5	DKK-06-22

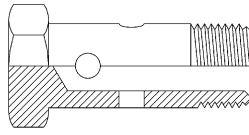

Hollow Bolt for Banjo Hose Fittings

Banjo Bolt Size	Part Number
1/8 BSPP	F15 R1/8
1/4 BSPP	F15 R1/4
3/8 BSPP	F15 R3/8
1/2 BSPP	F15 R1/2
5/8 BSPP	F15 R5/8
3/4 BSPP	F15 R3/4
1" BSPP	F15 R1
1-1/4 BSPP	F15 R11/4
1-1/2 BSPP	F15 R11/2
M10 x 1	F15 M10x1
M12 x 1.5	F15 M12x1.5
M14 x 1.5	F15 M14x1.5
M16 x 1.5	F15 M16x1.5
M18 x 1.5	F15 M8x1.5
M20 x 1.5	F15 M20x1.5
M22 x 1.5	F15 M22x1.5
M26 x 1.5	F15 M26x1.5
M27 x 2	F15 M27x2
M30 x 2	F15 M30x2
M33 x 2	F15 M33x2

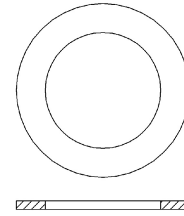

Copper Washer for Banjo Hose Fittings

Thread Size	Part Number
1/8 BSPP	CWR 1/8
1/4 BSPP	CWR 1/4
3/8 BSPP	CWR 3/8
1/2 BSPP	CWR 1/2
5/8 BSPP	CWR 5/8
3/4 BSPP	CWR 3/4
1" BSPP	CWR 01
1-1/4 BSPP	CWR 11/4
1-1/2 BSPP	CWR 11/2
M10 x 1	CWM 10
M12 x 1.5	CWM 12
M14 x 1.5	CWM 14
M16 x 1.5	CWM 16
M18 x 1.5	CWM 18
M20 x 1.5	CWM 20
M22 x 1.5	CWM 22
M26 x 1.5	CWM 26
M27 x 2	CWM 27
M30 x 2	CWM 30
M33 x 2	CWM 33



Interlock Crimp Ferrules / Interlock NPT Hose Fittings

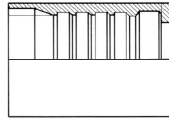

Crimp Ferrule 4SH Hose Interlock

Part Number

HPF-4SH-12
HPF-4SH-16
HPF-4SH-20
HPF-4SH-24
HPF-4SH-32

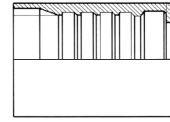

Crimp Ferrule 100R13 Hose Interlock

Part Number

HPF-13-12
HPF-13-16
HPF-13-20
HPF-13-24
HPF-13-32

Hose Size	Hose I.D.
-12	3/4"
-16	1"
-20	1-1/4"
-24	1-1/2"
-32	2"

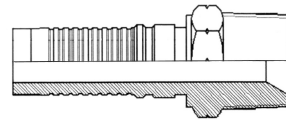

Male NPT Interlock

Part Number

HAGN-12-12
HAGN-16-16
HAGN-20-20
HAGN-24-24
HAGN-32-32

Hose Size	Hose I.D.	NPT Thread Size
-12	3/4"	3/4 -14
-16	1"	1 - 11.5
-20	1-1/4"	1 1/4 - 11.5
-24	1-1/2"	1 1/2 - 11.5
-32	2"	2 - 11.5



Interlock BSPP Hose Fittings

Hose Size	Hose I.D.	BSPP Thread
-12	3/4"	3/4 - 14
-16	1"	1 - 11
-20	1-1/4"	1 1/4 - 11
-24	1-1/2"	1 1/2 - 11
-32	2"	2 - 11

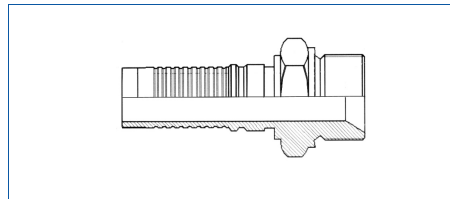

Male BSPP Interlock

Part Number
HAGR-12-12
HAGR-16-16
HAGR-20-20
HAGR-24-24
HAGR-32-32

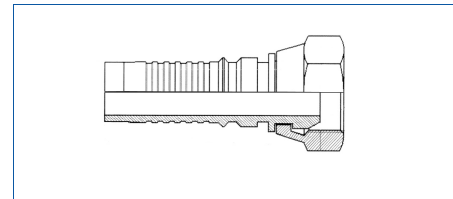

Female BSPP Interlock

Part Number
HDKR-12-12
HDKR-16-16
HDKR-20-20
HDKR-24-24
HDKR-32-32

Hose Size	Hose I.D.	BSPP Thread
-12	3/4"	3/4 - 14
-16	1"	1 - 11
-20	1-1/4"	1 1/4 - 11
-24	1-1/2"	1 1/2 - 11
-32	2"	2 - 11

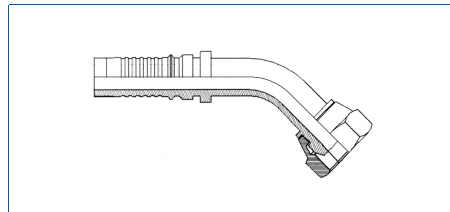

Female BSPP 45° Interlock

Model Number
HDKR-45-12-12
HDKR-45-16-16
HDKR-45-20-20
HDKR-45-24-24
HDKR-45-32-32

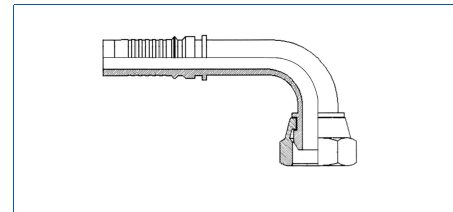

Female BSPP 90° Interlock

Model Number
HDKR-90-12-12
HDKR-90-16-16
HDKR-90-20-20
HDKR-90-24-24
HDKR-90-32-32



Interlock DIN2353 Hose Fittings

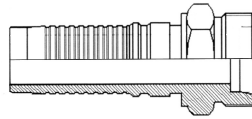

Male DIN2353 S Series Interlock

Part Number

HCES-12-30

HCES-12-36

HCES-16-42

HCES-20-52

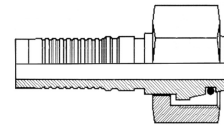

Female DIN2353 Interlock

Part Number

HDKOS-12-30

HDKOS-12-36

HDKOS-16-42

HDKOS-20-52

Hose Size	Hose I.D.	Tube Size	Thread
-12	3/4	20-S	M30x2
-12	3/4	25-S	M36x2
-16	1"	30-S	M42x2
-20	1-1/4	38-S	M52x2

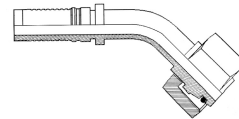

Female DIN2353 45° Interlock

Part Number

HDKOS-45-12-30

HDKOS-45-12-36

HDKOS-45-16-42

HDKOS-45-20-52

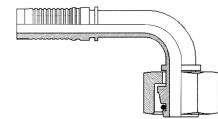

Female DIN2353 90° Interlock

Part Number

HDKOS-90-12-30

HDKOS-90-12-36

HDKOS-90-16-42

HDKOS-90-20-52

Hose Size	Hose I.D.	Tube Size	Thread
-12	3/4"	20-S	M30x2
-12	3/4"	25-S	M36x2
-16	1"	30-S	M42x2
-20	1-1/4"	38-S	M52x2



Hose Size	Hose I.D.	JIC Dash Size	JIC Thread
-12	3/4"	-12	1 ¹ / ₁₆ – 12
-16	1"	-16	1 ⁵ / ₁₆ – 12
-20	1-1/4"	-20	1 ⁵ / ₈ – 12
-24	1-1/2"	-24	1 ⁷ / ₈ – 12
-32	2"	-32	2 ¹ / ₂ – 12

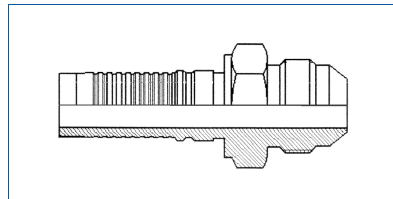

Male JIC Interlock

Model Number

HAGJ-12-12
 HAGJ-16-16
 HAGJ-20-20
 HAGJ-24-24
 HAGJ-32-32

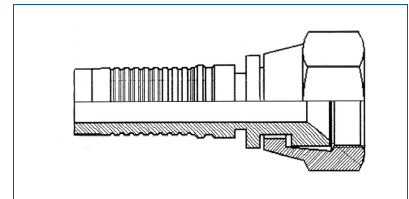

Female JIC Interlock

Model Number

HDKJ-12-12
 HDKJ-16-16
 HDKJ-20-20
 HDKJ-24-24
 HDKJ-32-32

Hose Size	Hose I.D.	JIC Dash Size	JIC Thread
-12	3/4"	-12	1 ¹ / ₁₆ – 12
-16	1"	-16	1 ⁵ / ₁₆ – 12
-20	1-1/4"	-20	1 ⁵ / ₈ – 12
-24	1-1/2"	-24	1 ⁷ / ₈ – 12

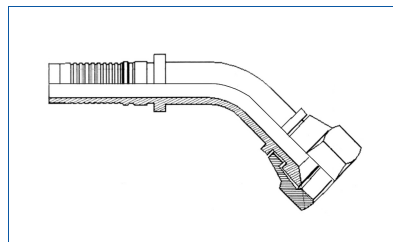

Female JIC 45° Interlock

Part Number

HDKJ-45-12-12
 HDKJ-45-16-16
 HDKJ-45-20-20
 HDKJ-45-24-24

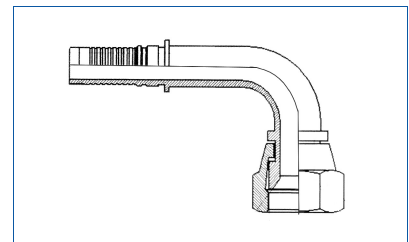

Female JIC 90° Interlock

Part Number

HDKJ-90-12-12
 HDKJ-90-16-16
 HDKJ-90-20-20
 HDKJ-90-24-24



Interlock Code 61 Flange Hose Fittings

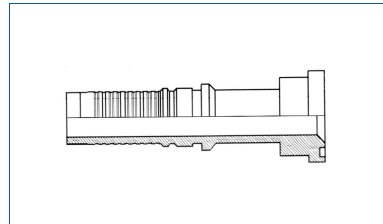

Code 61 Flange Interlock

Part Number

HFL3-12-12
 HFL3-12-16
 HFL3-16-16
 HFL3-16-20
 HFL3-20-20
 HFL3-20-24
 HFL3-24-24
 HFL3-24-32
 HFL3-32-32

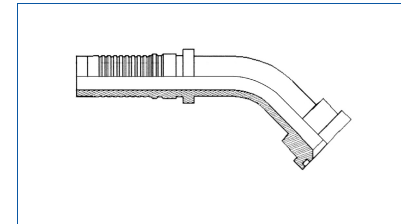

Code 61 Flange 45° Interlock

Part Number

HFL3-45-12-12
 HFL3-45-12-16
 HFL3-45-16-16
 HFL3-45-16-20
 HFL3-45-20-20
 HFL3-45-20-24

Hose Size	Hose I.D.	Flange Size	Flange O.D.
-12	3/4	-12	1.50"
-12	3/4	-16	1.75"
-16	1"	-16	1.75"
-16	1"	-20	2.00"
-20	1-1/4	-20	2.00"
-20	1-1/4	-24	2.38"
-24	1-1/2	-24	2.38"
-24	1-1/2	-32	2.81"
-32	2"	-32	2.81"

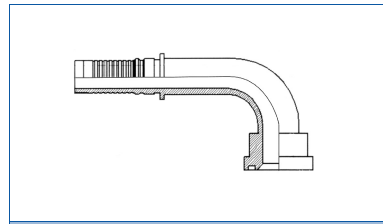

Code 61 Flange 90° Interlock

Part Number

HFL3-90-12-12
 HFL3-90-12-16
 HFL3-90-16-16
 HFL3-90-16-20
 HFL3-90-20-20

Hose Size	Hose I.D.	Flange Size	Flange O.D.
-12	3/4	-12	1.50"
-12	3/4	-16	1.75"
-16	1"	-16	1.75"
-16	1"	-20	2.00"
-20	1-1/4	-20	2.00"



Interlock Code 62 Flange Hose Fittings

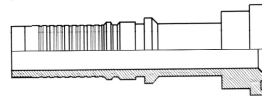

Code 62 Flange Interlock

Part Number

HFL6-12-12
 HFL6-12-16
 HFL6-16-16
 HFL6-16-20
 HFL6-20-20
 HFL6-20-24
 HFL6-24-24
 HFL6-24-32
 HFL6-32-32

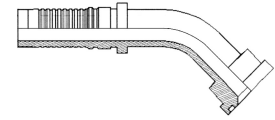

Code 62 Flange 45° Interlock

Part Number

HFL6-45-12-12
 HFL6-45-12-16
 HFL6-45-16-16
 HFL6-45-16-20
 HFL6-45-20-20
 HFL6-45-20-24
 HFL6-45-24-24
 HFL6-45-24-32
 HFL6-45-32-32

Hose Size	Hose I.D.	Flange Size	Flange O.D.
-12	3/4"	-12	1.63"
-12	3/4"	-16	1.88"
-16	1"	-16	1.88"
-16	1"	-20	2.13"
-20	1-1/4"	-20	2.13"
-20	1-1/4"	-24	2.50"
-24	1-1/2"	-24	2.50"
-24	1-1/2"	-32	3.13"
-32	2"	-32	3.13"

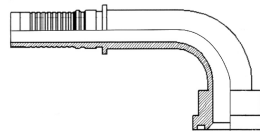

Code 62 Flange 90°

Model Number

HFL3-90-12-12
 HFL3-90-12-16
 HFL3-90-16-16
 HFL3-90-16-20
 HFL3-90-20-20
 HFL3-90-20-24
 HFL3-90-24-24
 HFL3-90-24-32
 HFL3-90-32-32

Hose Size	Hose I.D.	Flange Size	Flange O.D.
-12	3/4"	-12	1.63"
-12	3/4"	-16	1.88"
-16	1"	-16	1.88"
-16	1"	-20	2.13"
-20	1-1/4"	-20	2.13"
-20	1-1/4"	-24	2.50"
-24	1-1/2"	-24	2.50"
-24	1-1/2"	-32	3.13"
-32	2"	-32	3.13"



<p>RAGR - BSPP Male</p>	<p>RAGRK - BSPT Male</p>	<p>RAGJ - JIC Male</p>
<p>RAGN - NPT Male</p>	<p>RCEL - DIN2353L Male RCES - DIN2353S Male</p>	<p>RDKOL - DIN2353L Female RDKOS - DIN2353S Female</p>
<p>RDKOL45 - DIN2353L Female 45° Elbow RDKOS45 - DIN2353S Female 45° Elbow</p>	<p>RDKOL90 - DIN2353L Female 90° Elbow RDKOS90 - DIN2353S Female 90° Elbow</p>	<p>RBEM - Metric Standpipe</p>
<p>RBEM45 - Metric Standpipe 45° Elbow</p>	<p>RBEM90 - Metric Standpipe 90° Elbow</p>	<p>RDKR - BSPP Female</p>
<p>RDKR45 - BSPP Female 45° Elbow</p>	<p>RDKR90 - BSPP Female 90° Elbow</p>	<p>RDKJ - JIC Female</p>
<p>RDKJ45 - JIC Female 45° Elbow</p>	<p>RDKJ90 - JIC Female 90° Elbow</p>	<p>RHF - Hose Ferrule Re-useable</p>

Please enquire about available sizes and hose applications for re-useable hose fittings.



Low Pressure and General Purpose Hose

Oil, Gasoline and Pneumatic Use

		Oil and Gasoline Hose Type PZ (DIN 73379)	
		Synthetic rubber inner tube. Steel wire braided cover. Coloured marking thread. Temperature range -35°C to +80°C.	
Part Number	Inner diameter	Outer Diameter	Burst Pressure
PZ 4/5	4.5 mm	9.5 mm	60 bar
PZ 5/6	5.5 mm	10.5 mm	60 bar
PZ 8	7.5 mm	12.5 mm	50 bar
PZ 10	9.0 mm	14.0 mm	50 bar
PZ 12	11.5 mm	18.0 mm	50 bar
PZ 15	14.5 mm	22.0 mm	50 bar
PZ 18	17.0 mm	25.0 mm	50 bar
PZ 20	19.0 mm	29.0 mm	50 bar

		Oil and Gasoline Hose Type PZVA (DIN 73379)	
		Synthetic rubber inner tube. Stainless steel wire braided cover. Temperature range -35°C to +80°C	
Part Number	Inner diameter	Outer Diameter	Burst Pressure
PZ 5/6 VA	5.5 mm	10.5 mm	60 bar
PZ 8 VA	7.5 mm	12.5 mm	50 bar
PZ 10 VA	9.0 mm	15.0 mm	50 bar
PZ 12 VA	11.5 mm	18.0 mm	50 bar



Fittings for Low Pressure Hoses

	Crimp Sleeves Type H		
	Steel with zinc plating.		
Part Number	Inside Diameter (mm)	End Bore (mm)	Length (mm)
H 4/9	9.0	5.5	17.0
H 5/10	10.0	6.5	17.0
H 5/11	11.0	6.5	17.0
H 6/11	11.0	7.5	17.0
H 6/12/12	12.0	12.0	19.0
H 6/12	12.0	7.5	20.0
H 6/13.5	13.5	7.5	20.0
H 6/15	15.0	7.5	20.0
H 8/13.5	13.5	10.0	20.0
H 8/14	14.0	10.0	20.0
H 8/15	15.0	10.0	20.0
H 10/15	15.0	11.7	20.0
H 10/16	16.0	11.7	20.0
H 10/17	17.0	11.7	21.0
H 12/18	18.0	13.8	21.0
H 12/19	19.0	13.8	26.0
H 12/20	20.0	13.8	26.0
H 12/22	22.0	15.6	32.0
H 15/23	23.0	17.0	32.0
H 15/24.5	24.5	17.0	33.0
H 15/26.5	26.5	19.5	33.0
H 18/28	28.0	20.5	34.0
H 20/30	30.0	24.0	32.0
H 20/32	32.0	24.0	34.0
H 20/33	33.0	24.0	34.0
H 20/34	34.0	24.0	34.0
H 25/36	36.0	25.0	35.0
H 25/38	38.0	27.0	35.0
H 25/40	40.0	28.0	40.0

Choose crimp shells based on hose O.D. and end bore required.
 These shells are to be crimped on using a universal style crimper with 6 or 8 die fingers.



Fittings for Low Pressure Hoses

		Hose Nipple Type S
		For Female Swivel Similar to DIN 7608 Cone Seal
Part Number	Hose I.D. (mm)	Nut Required
S 5	5	UM 5/10, UM 5 1/8
S 6	6	UM 6/12, UM 6 1/4
S 6/8	6	UM 8/14
S 6/10	6	UM 10/16
S 8	8	UM 8/14, UM 8 1/4
S 8/10	8	UM 10/16
S 10	10	UM 10/16, UM 10 3/8
S 10/12	10	UM 12/18
S 12	12	UM 12/18
S 12/15	12	UM 15/22
S 15/22	15	UM 15/22
S 15/26	15	UM 18/26
S 18/26	18	UM 18/26
S 12 1/2	12	UM 1/2
S 15 1/2	15	UM 1/2
S20 3/4	20	UM 3/4
S 20 1	20	UM 1

		Hose Nipple Type S-F
		For Female Swivel Flat Seat
Part Number	Hose I.D. (mm)	Nut Required
S 5 F	5	UM 5/10, UM 5 1/8
S 6 F	6	UM 6/12, UM 6 1/4
S 8 F	8	UM 8/14, UM 8 1/4
S 10 F	10	UM 10/16, UM 10 3/8
S 12 F	12	UM 12/18
S 15/22 F	15	UM 15/22
S 15/26 F	15	UM 18/26
S 18/26 F	18	UM 18/26
S 12 1/2 F	12	UM 1/2
S 15 1/2 F	15	UM 1/2
S 20 3/4 F	20	UM 3/4
S 20 1F	20	UM 1

		Nut Type UM
		Similar to DIN 3870 With Metric & BSP Thread
Part Number	Nominal Bore	Thread Size
UM 5/10	3	M10 x 1
UM 6/12	4	M12 x 1.5
UM 8/14	6	M14 x 1.5
UM 10/16	8	M16 x 1.5
UM 12/18	10	M18 x 1.5
UM 15/22	12	M22 x 1.5
UM 18/26	16	M26 x 1.5
UM 5 1/8	3	1/8 BSP
UM 6 1/4	4	1/4 BSP
UM 8 1/4	6	1/4 BSP
UM 10 3/8	8	3/8 BSP
UM 1/2	10	1/2 BSP

		Banjo Hose Nipple Type RS
		Similar to DIN 7642
Part Number	Hose I.D. (mm)	Banjo Bolt Size
RS 5/6	4/5	6 mm
RS 5/8	5/6	8 mm
RS 6/10	5/6	10 mm, R1/8
RS 6/12	5/6	12 mm
RS 6/14	5/6	14 mm, R1/4
RS 8/10	8	10 mm, R1/8
RS 8/12	8	12 mm
RS 8/14	8	14 mm, R1/4
RS 10/12	10	12 mm
RS 10/14	10	14 mm, R1/4
RS 10/16	10	16 mm
RS 10/18	10	18 mm
RS 12/16	12	16 mm
RS 12/18	12	18 mm
RS 15/18	15	18 mm
RS 15/22	15	22 mm
RS 15/26	15	26 mm
RS 18/22	18	22 mm
RS 18/26	18	26 mm



Fittings for Low Pressure Hoses

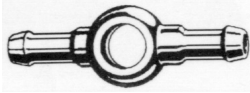

**Banjo Double
Hose Nipple
Type DRS**

Part Number	Hose I.D. (mm)	Banjo Bolt Size
DRS 5/8	5/6	8 mm
DRS 6/10	5/6	10 mm, R1/8
DRS 8/12	8	12 mm
DRS 10/14	10	14 mm, R1/4



**Standpipe
Hose Nipple
Type RST**

Part Number	Hose I.D. (mm)	Standpipe Size
RST 4	4/5	4 mm
RST 5	5/6	5 mm
RST 6	5/6	6 mm
RST 8	8	8 mm
RST 10	10	10 mm
RST 12	12	12 mm
RST 15	15	15 mm
RST 18	18	18 mm



**Standpipe Hose
Nipple 90°
Type RBS/90**

Part Number	Hose I.D. (mm)	Standpipe Size
RBS 4/90	4/5	4 mm
RBS 5/90	5/6	5 mm
RBS 6/90	5/6	6 mm
RBS 8/90	8	8 mm
RBS 10/90	10	10 mm
RBS 12/90	12	12 mm
RBS 15/90	15	15 mm



**Standpipe Hose
Nipple 45°
Type RBS/45**

Part Number	Hose I.D. (mm)	Standpipe Size
RBS 6/45	5/6	6 mm
RBS 8/45	8	8 mm
RBS 10/45	10	10 mm
RBS 12/45	12	12 mm
RBS 15/45	15	15 mm

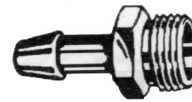

**Male Thread Hose Nipple
Type SA**

60° Cone Seat (KO)
Flat Seat (F)

Part Number	Hose I.D. (mm)	Thread Size
SA 5/10 KO	5/6	M 10x1
SA 6/12 KO	5/6	M 12x1.5
SA 8/14 KO	8	M 14x1.5
SA 10/16 KO	10	M 16x1.5
SA 12/18 KO	12	M 18x1.5
SA 15/22 KO	15	M 22x1.5
SA 15/26 KO	15	M 26x1.5
SA 18/26 KO	18	M 26x1.5
SA 15/22 F	15	M 22x1.5
SA 15/26 F	15	M 26x1.5
SA 18/26 F	18	M 26x1.5



**Male Thread Hose Nipple
Type SA**

24° Cone Seat for
Cutting Ring

Part Number	Hose I.D. (mm)	Thread Size	Tube Size
SA 5/10 S	5/6	M 10x1	5 LL
SA 6/12 S	5/6	M 12x1.5	6 L
SA 8/14 S	8	M 14x1.5	8 L
SA 10/16 S	10	M 16x1.5	10 L
SA 12/18 S	12	M 18x1.5	12 L
SA 15/22 S	15	M 22x1.5	15 L
SA 15/22/16	15	M 22x1.5	16 LL
SA 15/26 S	15	M 26x1.5	18 L
SA 18/26 S	18	M 26x1.5	18 L



Fittings for Low Pressure Hoses

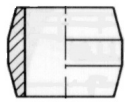

**Brass Compression Sleeves
For Metric Plastic Tubing**

Part Number	Tube Size
DKN 4	4 mm
DKN 5	5 mm
DKN 6	6 mm
DKN 8	8 mm
DKN 10	10 mm
DKN 12	12 mm



**Brass Reinforcing Sleeves
For Metric Plastic Tubing**

Part Number	Tube O.D. (mm)	Tube I.D. (mm)
VHP 4/1.0	4	2
VHP 5/1.0	5	3
VHP 6/1.0	6	4
VHP 8/1.0	8	6
VHP 8/1.5	8	5
VHP 9/1.5	9	6
VHP 10/1.0	10	8
VHP 10/1.25	10	7.5
VHP 10/1.5	10	7
VHP 11/1.5	11	8
VHP 12/1.5	12	9
VHP 12/2.0	12	8
VHP 14/2.0	14	10
VHP 15/1.5	15	12
VHP 16/2.0	16	12
VHP 18/2.0	18	14
VHP 22/2.0	22	18



**Grease Nipple Type SM A
Metric and BSP Thread**

Part Number	Thread Size
SM 6A	M 6x1
SM 8A	M 8x1
SM 10A	M 10x1
SM 14A	1/4 BSP
SM 18A	1/8 BSP



**Grease Nipple Type SM B
Metric and BSP Thread**

Part Number	Thread Size
SM 6B	M 6x1
SM 8B	M 8x1
SM 10B	M 10x1
SM 14B	1/4 BSP
SM 18B	1/8 BSP



**Grease Nipple Type SM C
Metric and BSP Thread**

Part Number	Thread Size
SM 6C	M 6x1
SM 8C	M 8x1
SM 10C	M 10x1
SM 14C	1/4 BSP
SM 18C	1/8 BSP



Stainless Steel Crimp Ferrules

Skive Type

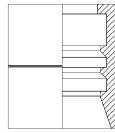

Hose Type: R1A

Part Number

PF-1-03SS
PF-1-04SS
PF-1-05SS
PF-1-06SS
PF-1-08SS
PF-1-10SS
PF-1-12SS
PF-1-16SS
PF-1-20SS
PF-1-24SS
PF-1-32SS

Skive Type

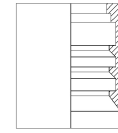

Hose Type: R2A & R12

Part Number

PF-2-03SS
PF-2-04SS
PF-2-05SS
PF-2-06SS
PF-2-08SS
PF-2-10SS
PF-2-12SS
PF-2-16SS
PF-2-20SS
PF-2-24SS
PF-2-32SS

Hose Size	Hose ID
-3	3/16"
-4	1/4"
-5	5/16"
-6	3/8"
-8	1/2"
-10	5/8"
-12	3/4"
-16	1"
-20	1-1/4"
-24	1-1/2"
-32	2"

No Skive

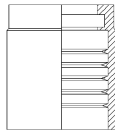

Hose Type: R1T & R2AT

Part Number

PF-1T-03SS, PF-2T-03SS
PF-1T/2T-04SS
PF-1T/2T-05SS
PF-1T/2T-06SS
PF-1T/2T-08SS
PF-1T/2T-10SS
PF-1T/2T-12SS
PF-1T/2T-16SS
PF-1T/2T-20SS
PF-1T/2T-24SS
PF-1T/2T-32SS



Hose Type: R7 & R8

Part Number

PF-7-03SS
PF-7-04SS
PF-7-05SS
PF-7-06SS
PF-7-08SS
PF-7-10SS
PF-7-12SS
PF-7-16SS

Hose Size	Hose ID
-3	3/16"
-4	1/4"
-5	5/16"
-6	3/8"
-8	1/2"
-10	5/8"
-12	3/4"
-16	1"
-20	1-1/4"
-24	1-1/2"
-32	2"

All ferrules must be crimped full length, preferably with an 8-finger crimper. Crimp specifications available.

Williams Fluidair Corporation Limited

1018 Salk Road Pickering, Ontario Canada L1W 3C5

T: 905-831-3222 F: 905-831-3284 E: service@williamsfluidair.com W: www.williamsfluidair.com

Hose Fittings

Page 29 of 49



Stainless Steel Crimp Ferrules

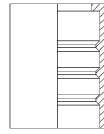

**Stainless Steel Braided Smooth
Bore Teflon Hose
Actual Hose ID**

Hose ID	Part Number
3/16"	PTTB-03SS
1/4"	PTTB-04SS
5/16"	PTTB-05SS
3/8"	PTTB-06SS
1/2"	PTTB-08SS
5/8"	PTTB-10SS
3/4"	PTTB-12SS
7/8"	PTTB-14SS
1"	PTTB-16SS
1-1/8"	PTTB-18SS

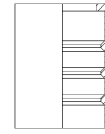

**Stainless Steel Braided
Convoluted Teflon Hose**

Hose ID	Part Number
3/16"	PTTC-03SS
1/4"	PTTC-04SS
5/16"	PTTC-05SS
3/8"	PTTC-06SS
1/2"	PTTC-08SS
5/8"	PTTC-10SS
3/4"	PTTC-12SS
1"	PTTC-16SS
1-1/4"	PTTC-20SS
1-1/2"	PTTC-24SS
2"	PTTC-32SS
2-1/2"	PTTC-40SS

All ferrules must be crimped full length, preferably with an 8-finger crimper.

Crimp specifications available.



Stainless Steel BSP Hose Fittings

Hose Size	Hose ID	BSPP Size	Thread Size
-2	1/8"	1/8	1/8 – 28
-3	3/16"	1/8	1/8 – 28
-3	3/16"	1/4	1/4 – 19
-4	1/4"	1/8	1/8 – 28
-4	1/4"	1/4	1/4 – 19
-4	1/4"	3/8	3/8 – 19
-4	1/4"	1/2	1/2 – 14
-5	5/16"	1/4	1/4 – 19
-5	5/16"	3/8	3/8 – 19
-6	3/8"	1/4	1/4 – 19
-6	3/8"	3/8	3/8 – 19
-6	3/8"	1/2	1/2 – 14
-8	1/2"	1/4	1/4 – 19
-8	1/2"	3/8	3/8 – 19
-8	1/2"	1/2	1/2 – 14
-8	1/2"	5/8	5/8 – 14
-8	1/2"	3/4	3/4 – 14
-10	5/8"	5/8	5/8 – 14
-10	5/8"	3/4	3/4 – 14
-12	3/4"	3/4	3/4 – 14
-12	3/4"	1	1 – 11
-16	1"	1	1 – 11
-16	1"	1-1/4	1 1/4 – 11
-20	1-1/4"	1-1/4	1 1/4 – 11
-24	1-1/2"	1-1/2	1 1/2 – 11
-24	1-1/2"	1-1/2	1 1/2 – 11
-32	2"	2	2 – 11

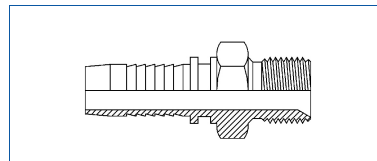

BSPP Male 60° Cone

Part Number
AGR-02-02-SS
AGR-03-02-SS
AGR-03-04-SS
AGR-04-02-SS
AGR-04-04-SS
AGR-04-06-SS
AGR-04-08-SS
AGR-05-06-SS
AGR-06-04-SS
AGR-06-06-SS
AGR-06-08-SS
AGR-08-04-SS
AGR-08-06-SS
AGR-08-08-SS
AGR-08-10-SS
AGR-08-12-SS
AGR-10-10-SS
AGR-10-12-SS
AGR-12-12-SS
AGR-12-16-SS
AGR-16-16-SS
AGR-16-20-SS
AGR-20-20-SS
AGR-20-24-SS
AGR-24-24-SS
AGR-32-32-SS

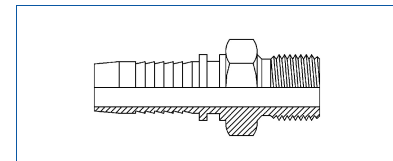

BSPP Male Flat Seat

Part Number
AGR-F-04-04-SS
AGR-F-05-06-SS
AGR-F-06-06-SS
AGR-F-06-08-SS
AGR-F-08-08-SS
AGR-F-10-10-SS
AGR-F-12-12-SS
AGR-F-12-16-SS
AGR-F-16-16-SS
AGR-F-16-20-SS
AGR-F-20-20-SS
AGR-F-24-24-SS
AGR-F-32-32-SS

Williams Fluidair Corporation Limited

1018 Salk Road Pickering, Ontario Canada L1W 3C5

T: 905-831-3222 F: 905-831-3284 E: service@williamsfluidair.com W: www.williamsfluidair.com

Hose Fittings

Page 31 of 49



Stainless Steel NPT & BSPT Hose Fittings

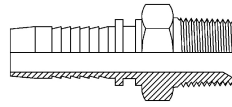

NPT Male

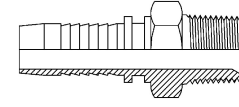

BSPT Male Tapered

Hose	Hose	Nominal Thread
-3	3/16"	1/8
-3	3/16"	1/4
-4	1/4"	1/8
-4	1/4"	1/4
-4	1/4"	3/8
-5	5/16"	1/4
-5	5/16"	3/8
-6	3/8"	1/4
-6	3/8"	3/8
-6	3/8"	1/2
-8	1/2"	3/8
-8	1/2"	1/2
-8	1/2"	5/8
-8	1/2"	3/4
-10	5/8"	1/2
-10	5/8"	5/8
-10	5/8"	3/4
-12	3/4"	3/4
-12	3/4"	1
-16	1"	1
-16	1"	1-1/4
-20	1-1/4"	1-1/4
-20	1-1/4"	1-1/2
-24	1-1/2"	1-1/2
-32	2"	2

NPT	Part Number
1/8 - 27	AGN-03-02-SS
1/4 - 18	AGN-03-04-SS
1/8 - 27	AGN-04-02-SS
1/4 - 18	AGN-04-04-SS
3/8 - 18	AGN-04-06-SS
1/4 - 18	AGN-05-04-SS
3/8 - 18	AGN-05-06-SS
1/4 - 18	AGN-06-04-SS
3/8 - 18	AGN-06-06-SS
1/2 - 14	AGN-06-08-SS
3/8 - 18	AGN-08-06-SS
1/2 - 14	AGN-08-08-SS
3/4 - 14	AGN-08-12-SS
1/2 - 14	AGN-10-08-SS
5/8 - 14	AGN-10-10-SS
3/4 - 14	AGN-10-12-SS
3/4 - 14	AGN-12-12-SS
1 - 11.5	AGN-12-16-SS
1 - 11.5	AGN-16-16-SS
1 1/4 - 11.5	AGN-16-20-SS
1 1/4 - 11.5	AGN-20-20-SS
1 1/2 - 11.5	AGN-20-24-SS
1 1/2 - 11.5	AGN-24-24-SS
2 - 11.5	AGN-32-32-SS

BSPT	Part Number
1/8 - 28	AGR-K-03-02-SS
1/8 - 28	AGR-K-04-02SS
1/4 - 19	AGR-K-04-04-SS
3/8 - 19	AGR-K-04-06-SS
1/4 - 19	AGR-K-05-04SS
3/8 - 19	AGR-K-05-06-SS
1/4 - 19	AGR-K-06-04-SS
3/8 - 19	AGR-K-06-06-SS
1/2 - 14	AGR-K-06-08-SS
1/2 - 14	AGR-K-08-08-SS
5/8 - 14	AGR-K-08-10-SS
3/4 - 14	AGR-K-08-12-SS
5/8 - 14	AGR-K-10-10-SS
3/4 - 14	AGR-K-10-12-SS
3/4 - 14	AGR-K-12-12-SS
1 - 11	AGR-K-12-16-SS
1 - 11	AGR-K-16-16-SS
1 1/4 - 11	AGR-K-16-20-SS
1 1/4 - 11	AGR-K-20-20-SS
1 1/2 - 11	AGR-K-20-24-SS
1 1/2 - 11	AGR-K-24-24-SS
2 - 11	AGR-K-32-32-SS



Stainless Steel BSP Hose Fittings

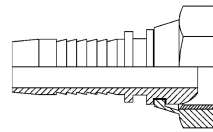

BSPP Swivel Female

Part Number

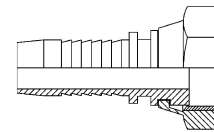

BSPP Swivel Female Flat Seat

Part Number

Hose Size	Hose ID	BSP Size	Thread Size
-3	3/16"	1/8	1/8 – 28
-3	3/16"	1/4	1/4 – 19
-4	1/4"	1/8	1/8 – 28
-4	1/4"	1/4	1/4 – 19
-4	1/4"	3/8	3/8 – 19
-4	1/4"	1/2	1/2 – 14
-5	5/16"	1/4	1/4 – 19
-5	5/16"	3/8	3/8 – 19
-6	3/8"	3/8	3/8 – 19
-6	3/8"	1/2	1/2 – 14
-8	1/2"	3/8	3/8 – 19
-8	1/2"	1/2	1/2 – 14
-8	1/2"	5/8	5/8 – 14
-8	1/2"	3/4	3/4 – 14
-10	5/8"	1/2	1/2 – 14
-10	5/8"	5/8	5/8 – 14
-10	5/8"	3/4	3/4 – 14
-12	3/4"	3/4	3/4 – 14
-12	3/4"	1	1 – 11
-16	1"	1	1 – 11
-16	1"	1-1/4	1 1/4 – 11
-20	1-1/4"	1-1/4	1 1/4 – 11
-20	1-1/4"	1-1/2	1 1/2 – 11
-24	1-1/2"	1-1/2	1 1/2 – 11
-24	1-1/2"	2	2 – 11
-32	2"	2	2 – 11

DKR-03-02-SS
DKR-03-04-SS
DKR-04-02-SS
DKR-04-04-SS
DKR-04-06-SS
DKR-05-04-SS
DKR-05-06-SS
DKR-06-06-SS
DKR-06-08-SS
DKR-08-08-SS
DKR-08-10-SS
DKR-08-12-SS
DKR-10-08-SS
DKR-10-10-SS
DKR-10-12-SS
DKR-12-12-SS
DKR-12-16-SS
DKR-16-16-SS
DKR-16-20-SS
DKR-20-20-SS
DKR-20-24-SS
DKR-24-24-SS
DKR-24-32-SS
DKR-32-32-SS

DKR-F-04-04-SS
DKR-F-04-06-SS
DKR-F-04-08-SS
DKR-F-05-06-SS
DKR-F-06-06-SS
DKR-F-06-08-SS
DKR-F-08-06-SS
DKR-F-08-08-SS
DKR-F-08-12-SS
DKR-F-10-12-SS
DKR-F-12-12-SS
DKR-F-16-16-SS
DKR-F-20-20-SS
DKR-F-24-24-SS
DKR-F-32-32-SS

The flat seat BSPP fittings are most often seen on HIAB cranes.

Williams Fluidair Corporation Limited

1018 Salk Road Pickering, Ontario Canada L1W 3C5

T: 905-831-3222 F: 905-831-3284 E: service@williamsfluidair.com W: www.williamsfluidair.com

Hose Fittings

Page 33 of 49



Stainless Steel BSP Hose Fittings

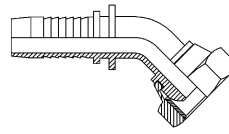

**BSPP Swivel Female
45° Elbow**

Part Number

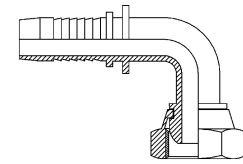

**BSPP Swivel Female
90° Elbow**

Part Number

Hose Size	Hose I.D.	BSP Size	Thread Size
-3	3/16"	1/4	1/4 – 19
-4	1/4"	1/4	1/4 – 19
-4	1/4"	3/8	3/8 – 19
-4	1/4"	1/2	1/4 – 14
-5	5/16"	3/8	3/8 – 19
-6	3/8"	3/8	3/8 – 19
-6	3/8"	1/2	1/2 – 14
-8	1/2"	1/2	1/2 – 14
-8	1/2"	3/4	3/4 – 14
-10	5/8"	5/8	5/8 – 14
-10	5/8"	3/4	3/4 – 14
-12	3/4"	3/4	3/4 – 14
-12	3/4"	1"	1 – 11
-16	1"	1"	1 – 11
-20	1-1/4"	1-1/4	1 1/4 – 11
-24	1-1/2"	1-1/2	1 1/2 – 11
-32	2"	2"	2 – 11

DKR-45-03-04-SS
DKR-45-04-04-SS
DKR-45-04-06-SS
DKR-45-05-06-SS
DKR-45-06-06-SS
DKR-45-06-08-SS
DKR-45-08-08-SS
DKR-45-10-10-SS
DKR-45-10-12-SS
DKR-45-12-12-SS
DKR-45-12-16-SS
DKR-45-16-16-SS
DKR-45-20-20-SS
DKR-45-24-24-SS
DKR-45-32-32-SS

DKR-90-03-04-SS
DKR-90-04-04-SS
DKR-90-04-06-SS
DKR-90-04-08-SS
DKR-90-05-06-SS
DKR-90-06-06-SS
DKR-90-06-08-SS
DKR-90-08-08-SS
DKR-90-08-12-SS
DKR-90-10-10-SS
DKR-90-10-12-SS
DKR-90-12-12-SS
DKR-90-12-16-SS
DKR-90-16-16-SS
DKR-90-20-20-SS
DKR-90-24-24-SS
DKR-90-32-32-SS



Stainless Steel Metric Standpipe Hose Fittings

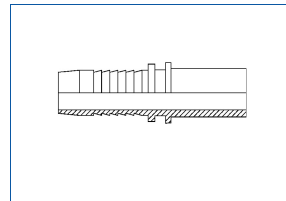

**Metric Standpipe
Straight**

Part Number

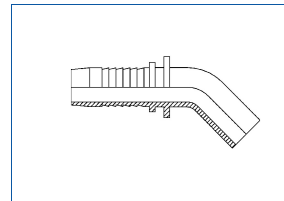

**Metric Standpipe
45° Elbow**

Part Number

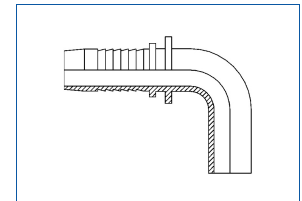

**Metric Standpipe
90° Elbow**

Part Number

Hose Size	Hose I.D.	Standpipe Size
-3	3/16"	6mm
-3	3/16"	8mm
-4	1/4"	6mm
-4	1/4"	8mm
-4	1/4"	10mm
-4	1/4"	12mm
-5	5/16"	8mm
-5	5/16"	10mm
-5	5/16"	12mm
-6	3/8"	8mm
-6	3/8"	10mm
-6	3/8"	12mm
-6	3/8"	14mm
-6	3/8"	15mm
-8	1/2"	12mm
-8	1/2"	14mm
-8	1/2"	15mm
-8	1/2"	16mm
-8	1/2"	18mm
-10	5/8"	18mm
-10	5/8"	20mm
-10	5/8"	22mm
-12	3/4"	18mm
-12	3/4"	20mm
-12	3/4"	22mm
-12	3/4"	25mm
-16	1"	25mm
-16	1"	28mm
-16	1"	30mm
-20	1-1/4"	35mm
-20	1-1/4"	38mm
-24	1-1/2"	42mm

BEM-03-06-SS
BEM-03-08-SS
BEM-04-06-SS
BEM-04-08-SS
BEM-04-10-SS
BEM-04-12-SS
BEM-05-10-SS
BEM-05-12-SS
BEM-06-08-SS
BEM-06-10-SS
BEM-06-12-SS
BEM-06-14-SS
BEM-06-15-SS
BEM-08-12-SS
BEM-08-14-SS
BEM-08-15-SS
BEM-08-16-SS
BEM-08-18-SS
BEM-10-18-SS
BEM-10-20-SS
BEM-10-22-SS
BEM-12-18-SS
BEM-12-20-SS
BEM-12-22-SS
BEM-12-25-SS
BEM-16-25-SS
BEM-16-28-SS
BEM-16-30-SS
BEM-20-35-SS
BEM-20-38-SS
BEM-24-42-SS

BEM-45-03-06-SS
BEM-45-04-06-SS
BEM-45-04-08-SS
BEM-45-04-10-SS
BEM-45-05-10-SS
BEM-45-05-12-SS
BEM-45-06-10-SS
BEM-45-06-12-SS
BEM-45-06-14-SS
BEM-45-08-14-SS
BEM-45-08-15-SS
BEM-45-08-16-SS
BEM-45-10-18-SS
BEM-45-10-20-SS
BEM-45-12-20-SS
BEM-45-12-22-SS
BEM-45-12-25-SS

BEM-90-03-06-SS
BEM-90-03-08-SS
BEM-90-04-06-SS
BEM-90-04-08-SS
BEM-90-04-10-SS
BEM-90-04-12-SS
BEM-90-05-08-SS
BEM-90-05-10-SS
BEM-90-05-12-SS
BEM-90-06-10-SS
BEM-90-06-12-SS
BEM-90-06-14-SS
BEM-90-06-15-SS
BEM-90-08-14-SS
BEM-90-08-15-SS
BEM-90-08-16-SS
BEM-90-08-18-SS
BEM-90-10-18-SS
BEM-90-10-20-SS
BEM-90-12-20-SS
BEM-90-12-22-SS
BEM-90-12-25-SS
BEM-90-16-28-SS
BEM-90-16-30-SS
BEM-90-20-35-SS
BEM-90-20-38-SS
BEM-90-24-42-SS

Standpipes are most often used to connect hose to DIN 2353 tube fittings.
This is a convenient way to combine hose and tubing in an installation.

Williams Fluidair Corporation Limited

1018 Salk Road Pickering, Ontario Canada L1W 3C5

T: 905-831-3222 F: 905-831-3284 E: service@williamsfluidair.com W: www.williamsfluidair.com



Stainless Steel Hose Fittings for DIN 2353 Tube Fittings (L Series, 24° Cone)

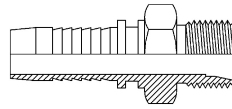

Metric Male 24°

Part Number

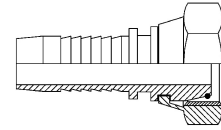

Female Swivel 24° with O-Ring

Part Number

Hose Size	Hose I.D.	Tube Size	Thread Size
-3	3/16"	6-L	M12x1.5
-4	1/4"	6-L	M12x1.5
-4	1/4"	8-L	M14x1.5
-4	1/4"	10-L	M16x1.5
-4	1/4"	12-L	M18x1.5
-5	5/16"	10-L	M16x1.5
-5	5/16"	12-L	M18x1.5
-6	3/8"	10-L	M16x1.5
-6	3/8"	12-L	M18x1.5
-6	3/8"	15-L	M22x1.5
-8	1/2"	15-L	M22x1.5
-8	1/2"	18-L	M26x1.5
-10	5/8"	18-L	M26x1.5
-12	3/4"	22-L	M30x2
-16	1"	28-L	M36x2
-20	1-1/4"	35-L	M45x2
-24	1-1/2"	42-L	M52x2
-32	2"	42-L	M52x2

CEL-04-12-SS
CEL-04-14-SS
CEL-04-16-SS
CEL-04-18-SS
CEL-05-16-SS
CEL-05-18-SS
CEL-06-16-SS
CEL-06-18-SS
CEL-08-22-SS
CEL-08-26-SS
CEL-10-26-SS
CEL-12-30-SS
CEL-16-36-SS
CEL-20-45-SS
CEL-24-52-SS

DKOL-03-12-SS
DKOL-04-12-SS
DKOL-04-14-SS
DKOL-04-16-SS
DKOL-04-18-SS
DKOL-05-16-SS
DKOL-05-18-SS
DKOL-06-16-SS
DKOL-06-18-SS
DKOL-06-22-SS
DKOL-08-22-SS
DKOL-08-26-SS
DKOL-10-26-SS
DKOL-12-30-SS
DKOL-16-36-SS
DKOL-20-45-SS
DKOL-24-52-SS
DKOL-32-52-SS

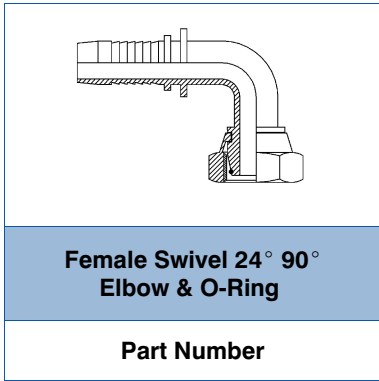
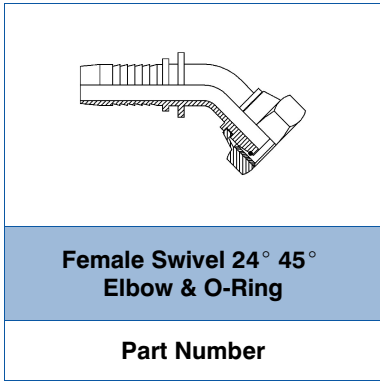

Hose Size	Hose I.D.	Tube Size	Thread Size
-3	3/16"	6-L	M12x1.5
-4	1/4"	6-L	M12x1.5
-4	1/4"	8-L	M14x1.5
-4	1/4"	10-L	M16x1.5
-5	5/16"	10-L	M16x1.5
-5	5/16"	12-L	M18x1.5
-6	3/8"	10-L	M16x1.5
-6	3/8"	12-L	M18x1.5
-8	1/2"	15-L	M22x1.5
-10	5/8"	18-L	M26x1.5
-12	3/4"	22-L	M30x2
-16	1"	28-L	M36x2
-20	1-1/4"	35-L	M45x2
-24	1-1/2"	42-L	M52x2

DKOL-45-03-12-SS
DKOL-45-04-12-SS
DKOL-45-04-14-SS
DKOL-45-04-16-SS
DKOL-45-05-16-SS
DKOL-45-06-16-SS
DKOL-45-06-18-SS
DKOL-45-08-22-SS
DKOL-45-10-26-SS
DKOL-45-12-30-SS
DKOL-45-16-36-SS
DKOL-45-20-45-SS
DKOL-45-24-52-SS

DKOL-90-04-12-SS
DKOL-90-04-14-SS
DKOL-90-04-16-SS
DKOL-90-05-16-SS
DKOL-90-05-18-SS
DKOL-90-06-16-SS
DKOL-90-06-18-SS
DKOL-90-08-22-SS
DKOL-90-10-26-SS
DKOL-90-12-30-SS
DKOL-90-16-36-SS
DKOL-90-20-45-SS
DKOL-90-24-52-SS



Stainless Steel Hose Fittings for DIN 2353 Tube Fittings (S Series, 24° Cone)

Hose Size	Hose I.D.	Tube Size	Thread Size
-4	1/4"	8-S	M16x1.5
-4	1/4"	10-S	M18x1.5
-5	5/16"	10-S	M18x1.5
-5	5/16"	12-S	M20x1.5
-6	3/8"	10-S	M18x1.5
-6	3/8"	12-S	M20x1.5
-6	3/8"	14-S	M22x1.5
-8	1/2"	14-S	M22x1.5
-8	1/2"	16-S	M24x1.5
-10	5/8"	20-S	M30x2
-12	3/4"	30-S	M30x2
-12	3/4"	25-S	M36x2
-16	1"	25-S	M36x2
-16	1"	30-S	M42x2
-20	1-1/4"	38-S	M52x2

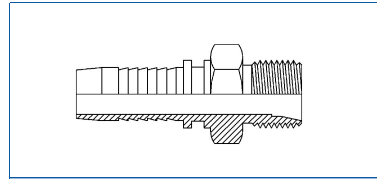

Metric Male 24°

Part Number
CES-04-16-SS
CES-04-18-SS
CES-05-18-SS
CES-05-20-SS
CES-06-18-SS
CES-06-20-SS
CES-06-22-SS
CES-08-22-SS
CES-08-24-SS
CES-10-30-SS
CES-12-30-SS
CES-12-36-SS
CES-16-36-SS
CES-16-42-SS
CES-20-52-SS

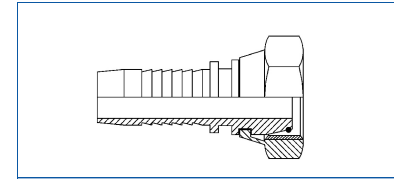

Female Swivel 24° with O-Ring

Part Number
DKOS-04-16-SS
DKOS-04-18-SS
DKOS-05-20-SS
DKOS-06-20-SS
DKOS-06-22-SS
DKOS-08-24-SS
DKOS-10-30-SS
DKOS-12-30-SS
DKOS-12-36-SS
DKOS-16-36-SS
DKOS-16-42-SS
DKOS-20-52-SS

Hose Size	Hose I.D.	Tube Size	Thread Size
-4	1/4"	6-S	M14x1.5
-4	1/4"	8-S	M16x1.5
-4	1/4"	10-S	M18x1.5
-5	5/16"	12-S	M20x1.5
-6	3/8"	12-S	M20x1.5
-6	3/8"	14-S	M22x1.5
-8	1/2"	16-S	M24x1.5
-10	5/8"	20-S	M30x2
-12	3/4"	20-S	M30x2
-12	3/4"	25-S	M36x2
-16	1"	25-S	M36x2
-16	1"	30-S	M42x2
-20	1-1/4"	38-S	M50x2

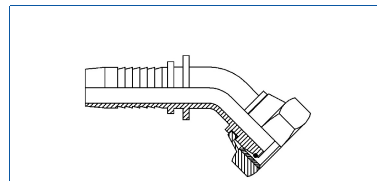

Female Swivel 24° 45° Elbow & O-Ring

Part Number
DKOS-45-04-14-SS
DKOS-45-04-16-SS
DKOS-45-04-18-SS
DKOS-45-05-20-SS
DKOS-45-06-20-SS
DKOS-45-06-22-SS
DKOS-45-08-24-SS
DKOS-45-10-30-SS
DKOS-45-12-30-SS
DKOS-45-12-36-SS
DKOS-45-16-36-SS
DKOS-45-16-42-SS
DKOS-45-20-52-SS

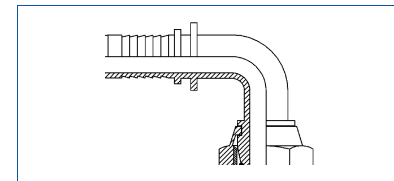

Female Swivel 24° 90° Elbow & O-Ring

Part Number
DKOS-90-04-14-SS
DKOS-90-04-16-SS
DKOS-90-04-18-SS
DKOS-90-05-20-SS
DKOS-90-06-20-SS
DKOS-90-06-22-SS
DKOS-90-08-24-SS
DKOS-90-10-30-SS
DKOS-90-12-30-SS
DKOS-90-12-36-SS
DKOS-90-16-36-SS
DKOS-90-16-42-SS
DKOS-90-20-52-SS

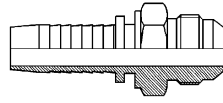

Male JIC

Part Number

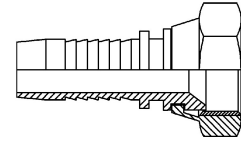

Female JIC

Part Number

Hose Size	Hose I.D.	JIC Dash Size	Thread Size
-3	3/16"	-4	7/16 – 20
-4	1/4"	-4	7/16 – 20
-4	1/4"	-5	1/2 – 20
-4	1/4"	-6	9/16 – 18
-4	1/4"	-8	3/4 – 16
-5	5/16"	-5	1/2 – 20
-5	5/16"	-6	9/16 – 18
-6	3/8"	-6	9/16 – 18
-6	3/8"	-8	3/4 – 16
-6	3/8"	-10	7/8 – 14
-8	1/2"	-8	3/4 – 16
-8	1/2"	-10	7/8 – 14
-8	1/2"	-12	1 ¹ / ₁₆ – 12
-10	5/8"	-10	7/8 – 14
-10	5/8"	-12	1 ¹ / ₁₆ – 12
-12	3/4"	-12	1 ¹ / ₁₆ – 12
-12	3/4"	-16	1 ⁵ / ₁₆ – 12
-16	1"	-12	1 ¹ / ₁₆ – 12
-16	1"	-16	1 ⁵ / ₁₆ – 12
-16	1"	-20	1 ⁵ / ₈ – 12
-20	1-1/4"	-20	1 ⁵ / ₈ – 12
-24	1-1/2"	-24	1 ⁷ / ₈ – 12
-32	2"	-32	2 ¹ / ₂ – 12

AGJ-04-04-SS
AGJ-04-05-SS
AGJ-04-06-SS
AGJ-04-08-SS
AGJ-05-05-SS
AGJ-05-06-SS
AGJ-06-06-SS
AGJ-06-08-SS
AGJ-06-10-SS
AGJ-08-08-SS
AGJ-08-10-SS
AGJ-10-10-SS
AGJ-10-12-SS
AGJ-12-12-SS
AGJ-12-16-SS
AGJ-16-12-SS
AGJ-16-16-SS
AGJ-16-20-SS
AGJ-20-20-SS
AGJ-24-24-SS
AGJ-32-32-SS

DKJ-03-04-SS
DKJ-04-04-SS
DKJ-04-05-SS
DKJ-04-06-SS
DKJ-05-05-SS
DKJ-05-06-SS
DKJ-06-06-SS
DKJ-06-08-SS
DKJ-06-10-SS
DKJ-08-08-SS
DKJ-08-10-SS
DKJ-08-12-SS
DKJ-10-10-SS
DKJ-10-12-SS
DKJ-12-12-SS
DKJ-12-16-SS
DKJ-16-12-SS
DKJ-16-16-SS
DKJ-16-20-SS
DKJ-20-20-SS
DKJ-24-24-SS
DKJ-32-32-SS

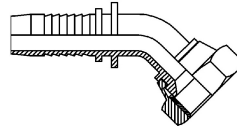

Female JIC 45°

Part Number

- DKJ-45-03-04-SS
- DKJ-45-04-04-SS
- DKJ-45-04-05-SS
- DKJ-45-04-06-SS
- DKJ-45-05-05-SS
- DKJ-45-05-06-SS
- DKJ-45-06-06-SS
- DKJ-45-06-08-SS
- DKJ-45-06-10-SS
- DKJ-45-08-08-SS
- DKJ-45-08-10-SS
- DKJ-45-10-10-SS
- DKJ-45-10-12-SS
- DKJ-45-12-12-SS
- DKJ-45-12-16-SS
- DKJ-45-16-16-SS
- DKJ-45-16-20-SS
- DKJ-45-20-20-SS
- DKJ-45-20-24-SS
- DKJ-45-24-24-SS
- DKJ-45-32-32-SS

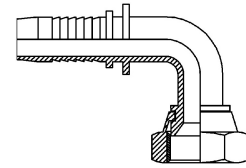

Female JIC 90°

Part Number

- DKJ-90-03-04-SS
- DKJ-90-04-04-SS
- DKJ-90-04-05-SS
- DKJ-90-04-06-SS
- DKJ-90-05-05-SS
- DKJ-90-05-06-SS
- DKJ-90-06-06-SS
- DKJ-90-06-08-SS
- DKJ-90-06-10-SS
- DKJ-90-08-08-SS
- DKJ-90-08-10-SS
- DKJ-90-10-10-SS
- DKJ-90-10-12-SS
- DKJ-90-12-12-SS
- DKJ-90-12-16-SS
- DKJ-90-16-16-SS
- DKJ-90-16-20-SS
- DKJ-90-20-20-SS
- DKJ-90-20-24-SS
- DKJ-90-24-24-SS
- DKJ-90-32-32-SS

Hose Size	Hose I.D.	JIC Dash Size	Thread Size
-3	3/16"	-4	7/16 – 20
-4	1/4"	-4	7/16 – 20
-4	1/4"	-5	1/2 – 20
-4	1/4"	-6	9/16 – 18
-5	5/16"	-5	1/2 – 20
-5	5/16"	-6	9/16 – 18
-6	3/8"	-6	9/16 – 18
-6	3/8"	-8	3/4 – 16
-6	3/8"	-10	7/8 – 14
-8	1/2"	-8	3/4 – 16
-8	1/2"	-10	7/8 – 14
-10	5/8"	-10	7/8 – 14
-10	5/8"	-12	1 1/16 – 12
-12	3/4"	-12	1 1/16 – 12
-12	3/4"	-16	1 5/16 – 12
-16	1"	-16	1 5/16 – 12
-16	1"	-20	1 5/8 – 12
-20	1-1/4"	-20	1 5/8 – 12
-20	1-1/4"	-24	1 7/8 – 12
-24	1-1/2"	-24	1 7/8 – 12
-32	2"	-32	2 1/2 – 12



Stainless Steel Code 61 Flange

Hose Size	Hose I.D.	Flange Dash Size	Flange O.D.
-8	1/2"	-8	1.19"
-8	1/2"	-12	1.50"
-10	5/8"	-12	1.50"
-12	3/4"	-12	1.50"
-12	3/4"	-16	1.75"
-16	1"	-16	1.75"
-16	1"	-20	2.00"
-20	1-1/4"	-20	2.00"
-20	1-1/4"	-24	2.38"
-24	1-1/2"	-24	2.38"
-24	1-1/2"	-32	2.81"
-32	2"	-32	2.81"

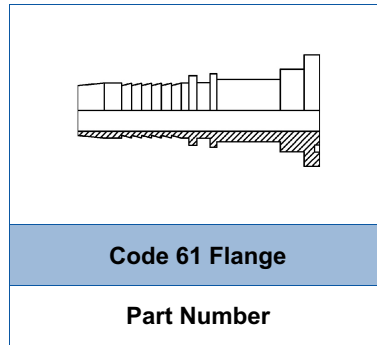

FL3-08-08-SS
FL3-08-12-SS
FL3-10-12-SS
FL3-12-12-SS
FL3-12-16-SS
FL3-16-16-SS
FL3-16-20-SS
FL3-20-20-SS
FL3-20-24-SS
FL3-24-24-SS
FL3-24-32-SS
FL3-32-32-SS

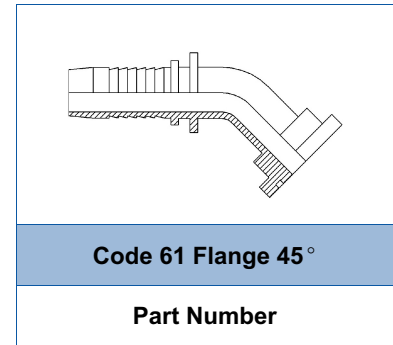

FL3-45-08-08-SS
FL3-45-08-12-SS
FL3-45-10-12-SS
FL3-45-12-12-SS
FL3-45-12-16-SS
FL3-45-16-16-SS
FL3-45-16-20-SS
FL3-45-20-20-SS
FL3-45-20-24-SS
FL3-45-24-24-SS
FL3-45-24-32-SS
FL3-45-32-32-SS

Hose Size	Hose I.D.	Flange Dash Size	Flange O.D.
-8	1/2"	-8	1.19"
-8	1/2"	-12	1.50"
-10	5/8"	-12	1.50"
-12	3/4"	-12	1.50"
-12	3/4"	-16	1.75"
-16	1"	-16	1.75"
-16	1"	-20	2.00"
-20	1-1/4"	-20	2.00"
-20	1-1/4"	-24	2.38"
-24	1-1/2"	-24	2.38"
-24	1-1/2"	-32	2.81"
-32	2"	-32	2.81"

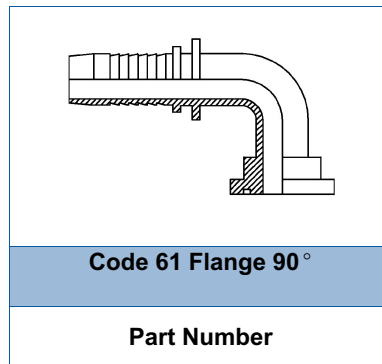

FL3-90-08-08-SS
FL3-90-08-12-SS
FL3-90-10-12-SS
FL3-90-12-12-SS
FL3-90-12-16-SS
FL3-90-16-16-SS
FL3-90-16-20-SS
FL3-90-20-20-SS
FL3-90-20-24-SS
FL3-90-24-24-SS
FL3-90-24-32-SS
FL3-90-32-32-SS

Williams Fluidair Corporation Limited

1018 Salk Road Pickering, Ontario Canada L1W 3C5

T: 905-831-3222 F: 905-831-3284 E: service@williamsfluidair.com W: www.williamsfluidair.com



Stainless Steel Code 62 Flange

Hose Size	Hose I.D.	Flange Dash Size	Flange O.D.
-8	1/2"	-8	1.25"
-8	1/2"	-12	1.63"
-10	5/8"	-12	1.63"
-12	3/4"	-12	1.63"
-12	3/4"	-16	1.88"
-16	1"	-16	1.88"
-16	1"	-20	2.13"
-20	1-1/4"	-20	2.13"
-20	1-1/4"	-24	2.50"
-24	1-1/2"	-24	2.50"
-24	1-1/2"	-32	3.13"
-32	2"	-32	3.13"

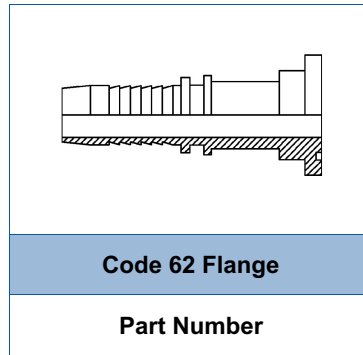

FL6-08-08-SS
FL6-08-12-SS
FL6-10-12-SS
FL6-12-12-SS
FL6-12-16-SS
FL6-16-16-SS
FL6-16-20-SS
FL6-20-20-SS
FL6-20-24-SS
FL6-24-24-SS
FL6-24-32-SS
FL6-32-32-SS

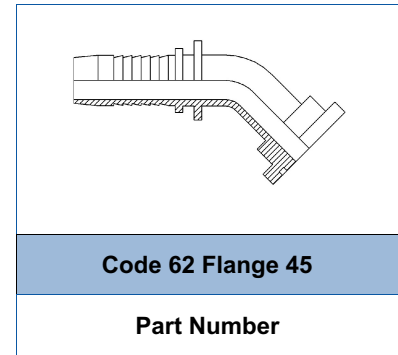

FL6-45-08-08-SS
FL6-45-08-12-SS
FL6-45-10-12-SS
FL6-45-12-12-SS
FL6-45-12-16-SS
FL6-45-16-16-SS
FL6-45-16-20-SS
FL6-45-20-20-SS
FL6-45-20-24-SS
FL6-45-24-24-SS
FL6-45-24-32-SS
FL6-45-32-32-SS

Hose Size	Hose I.D.	Flange Dash Size	Flange O.D.
-8	1/2"	-8	1.25"
-8	1/2"	-12	1.63"
-10	5/8"	-12	1.63"
-12	3/4"	-12	1.63"
-12	3/4"	-16	1.88"
-16	1"	-16	1.88"
-16	1"	-20	2.13"
-20	1-1/4"	-20	2.13"
-20	1-1/4"	-24	2.50"
-24	1-1/2"	-24	2.50"
-24	1-1/2"	-32	3.13"
-32	2"	-32	3.13"

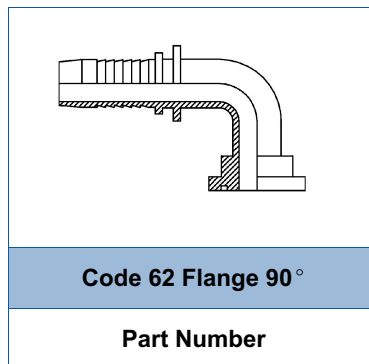

FL6-90-08-08-SS
FL6-90-08-12-SS
FL6-90-10-12-SS
FL6-90-12-12-SS
FL6-90-12-16-SS
FL6-90-16-16-SS
FL6-90-16-20-SS
FL6-90-20-20-SS
FL6-90-20-24-SS
FL6-90-24-24-SS
FL6-90-24-32-SS
FL6-90-32-32-SS



Miscellaneous Stainless Steel Hose Fittings

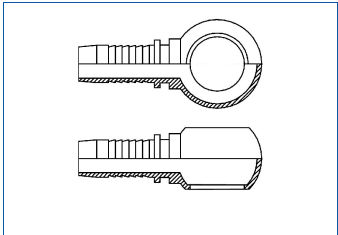

Banjo Hose End

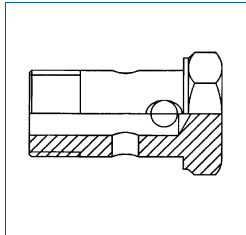

Banjo Bolt

Hose Size	Hose I.D.	Bolt Size	RNM / RNR
			Part Number
-4	1/4"	M1	RNM-04-12-SS
-4	1/4"	M1	RNM-04-14-SS
-5	5/16"	M1	RNM-05-16-SS
-6	3/8"	M1	RNM-06-14-SS
-6	3/8"	M1	RNM-06-16-SS
-6	3/8"	M1	RNM-06-18-SS
-8	1/2"	M1	RNM-08-18-SS
-8	1/2"	M2	RNM-08-20-SS
-8	1/2"	M2	RNM-08-22-SS
-12	3/4"	M2	RNM-12-26-SS
-12	3/4"	M3	RNM-12-30-SS
-4	1/4"	1/4	RNR-04-04-SS
-5	5/16"	3/8	RNR-05-06-SS
-6	3/8"	3/8	RNR-06-06-SS
-6	3/8"	1/2	RNR-06-08-SS
-8	1/2"	3/8	RNR-08-06-SS
-8	1/2"	1/2	RNR-08-08-SS
-8	1/2"	3/4	RNR-08-12-SS
-12	3/4"	3/4	RNR-12-12-SS
-16	1"	1"	RNR-16-16SS

Bolt Thread	F15
	Part Number
M12 X 1.5	F15 M12X1.5 SS
M14 X 1.5	F15 M14X1.5 SS
M16 X 1.5	F15 M16X1.5 SS
M18 X 1.5	F15 M18X1.5 SS
M20 X 1.5	F15 M20X1.5 SS
M22 X 1.5	F15 M22X1.5 SS
M26 X 1.5	F15 M26X1.5 SS
M30 X 1.5	F15 M30X1.5 SS
1/4 BSPP	F15 R1/4 SS
3/8 BSPP	F15 R3/8 SS
1/2 BSPP	F15 R1/2 SS
3/4 BSPP	F15 R3/4 SS
1 BSPP	F15 R1 SS



316SS Interlock Crimp Ferrules / 316SS Interlock NPT Hose Fittings

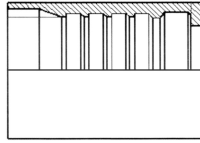

Crimp Ferrule 4SH Hose Interlock

Part Number

HPF-4SH-12SS
 HPF-4SH-16SS
 HPF-4SH-20SS
 HPF-4SH-24SS
 HPF-4SH-32SS

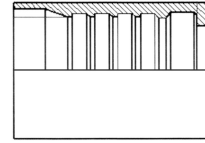

Crimp Ferrule 100R13 Hose Interlock

Part Number

HPF-13-12SS
 HPF-13-16SS
 HPF-13-20SS
 HPF-13-24SS
 HPF-13-32SS

Hose Size	Hose I.D.
-12	3/4"
-16	1"
-20	1-1/4"
-24	1-1/2"
-32	2"

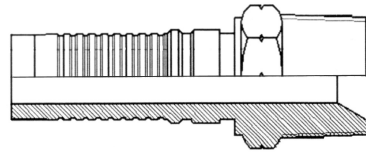

Male NPT Interlock

Part Number

HAGN-12-12-SS
 HAGN-16-16-SS
 HAGN-20-20-SS
 HAGN-24-24-SS
 HAGN-32-32-SS

Hose Size	Hose I.D.	NPT Thread Size
-12	3/4"	3/4 -14
-16	1"	1 - 11.5
-20	1-1/4"	1 1/4 - 11.5
-24	1-1/2"	1 1/2 - 11.5
-32	2"	2 - 11.5



316SS Interlock BSPP Hose Fittings

Hose Size	Hose I.D.	BSPP Thread
-12	3/4"	3/4 - 14
-16	1"	1 - 11
-20	1-1/4"	1 1/4 - 11
-24	1-1/2"	1 1/2 - 11
-32	2"	2 - 11

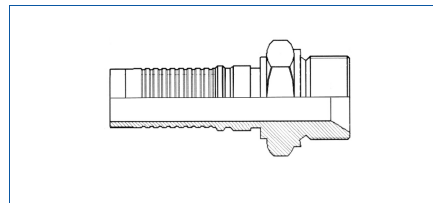

Male BSPP Interlock

Part Number
HAGR-12-12-SS
HAGR-16-16-SS
HAGR-20-20-SS
HAGR-24-24-SS
HAGR-32-32-SS

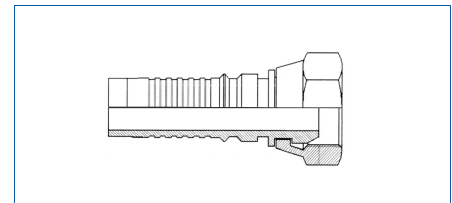

Female BSPP Interlock

Part Number
HDKR-12-12-SS
HDKR-16-16-SS
HDKR-20-20-SS
HDKR-24-24-SS
HDKR-32-32-SS

Hose Size	Hose I.D.	BSPP Thread
-12	3/4	3/4 - 14
-16	1"	1 - 11
-20	1-1/4	1 1/4 - 11
-24	1-1/2	1 1/2 - 11
-32	2"	2 - 11

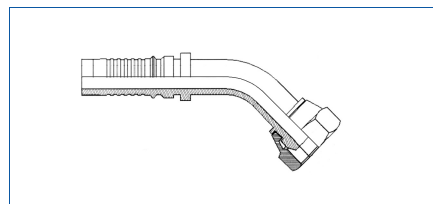

Female BSPP 45° Interlock

Model Number
HDKR-45-12-12-SS
HDKR-45-16-16-SS
HDKR-45-20-20-SS
HDKR-45-24-24-SS
HDKR-45-32-32-SS

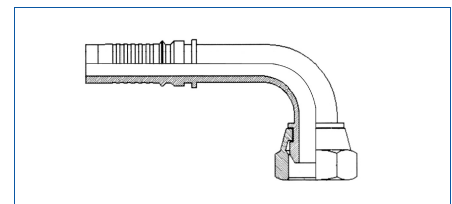

Female BSPP 90° Interlock

Model Number
HDKR-90-12-12-SS
HDKR-90-16-16-SS
HDKR-90-20-20-SS
HDKR-90-24-24-SS
HDKR-90-32-32-SS



316SS Interlock DIN2353 Hose Fittings

Hose Size	Hose I.D.	Tube Size	Thread
-12	3/4	20-S	M30x2
-12	3/4	25-S	M36x2
-16	1"	30-S	M42x2
-20	1-1/4"	38-S	M52x2

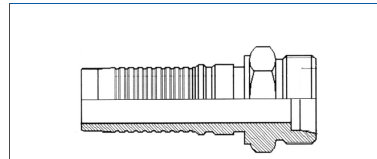

Male DIN2353 S Series Interlock

Part Number

HCES-12-30-SS

HCES-12-36-SS

HCES-16-42-SS

HCES-20-52-SS

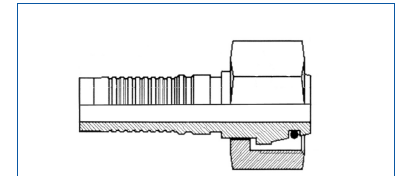

Female DIN2353 Interlock

Part Number

HDKOS-12-30-SS

HDKOS-12-36-SS

HDKOS-16-42-SS

HDKOS-20-52-SS

Hose Size	Hose I.D.	Tube Size	Thread
-12	3/4"	20-S	M30x2
-12	3/4"	25-S	M36x2
-16	1"	30-S	M42x2
-20	1-1/4"	38-S	M52x2

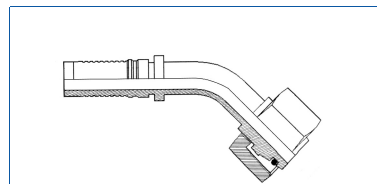

Female DIN2353 45° Interlock

Part Number

HDKOS-45-12-30-SS

HDKOS-45-12-36-SS

HDKOS-45-16-42-SS

HDKOS-45-20-52-SS

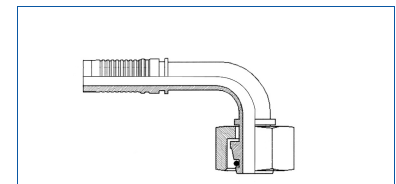

Female DIN2353 90° Interlock

Part Number

HDKOS-90-12-30-SS

HDKOS-90-12-36-SS

HDKOS-90-16-42-SS

HDKOS-90-20-52-SS



316SS Interlock JIC Hose Fittings

Hose Size	Hose I.D.	JIC Dash Size	JIC Thread
-12	3/4"	-12	1 ¹ / ₁₆ – 12
-16	1"	-16	1 ⁵ / ₁₆ – 12
-20	1-1/4"	-20	1 ⁵ / ₈ – 12
-24	1-1/2"	-24	1 ⁷ / ₈ – 12
-32	2"	-32	2 ¹ / ₂ – 12

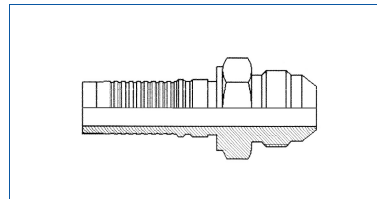

Male JIC Interlock

Model Number

HAGJ-12-12-SS
HAGJ-16-16-SS
HAGJ-20-20-SS
HAGJ-24-24-SS
HAGJ-32-32-SS

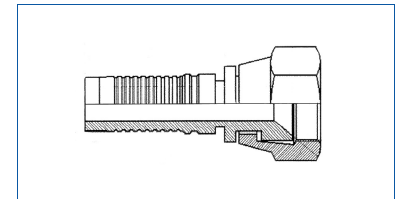

Female JIC Interlock

Model Number

HDKJ-12-12-SS
HDKJ-16-16-SS
HDKJ-20-20-SS
HDKJ-24-24-SS
HDKJ-32-32-SS

Hose Size	Hose I.D.	JIC Dash Size	JIC Thread
-12	3/4	-12	1 ¹ / ₁₆ – 12
-16	1"	-16	1 ⁵ / ₁₆ – 12
-20	1-1/4	-20	1 ⁵ / ₈ – 12
-24	1-1/2	-24	1 ⁷ / ₈ – 12

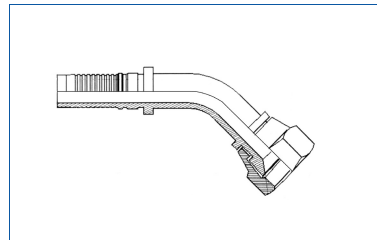

Female JIC 45° Interlock

Part Number

HDKJ-45-12-12-SS
HDKJ-45-16-16-SS
HDKJ-45-20-20-SS
HDKJ-45-24-24-SS

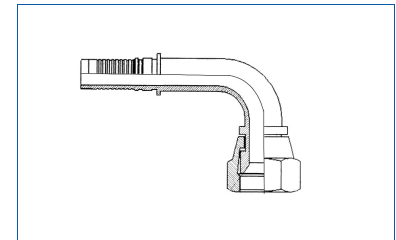

Female JIC 90° Interlock

Part Number

HDKJ-90-12-12-SS
HDKJ-90-16-16-SS
HDKJ-90-20-20-SS
HDKJ-90-24-24-SS



316SS Interlock Code 61 Flange Hose Fittings

Hose Size	Hose I.D.	Flange Size	Flange O.D.
-12	3/4	-12	1.50"
-12	3/4	-16	1.75"
-16	1"	-16	1.75"
-16	1"	-20	2.00"
-20	1-1/4	-20	2.00"
-20	1-1/4	-24	2.38"
-24	1-1/2	-24	2.38"
-24	1-1/2	-32	2.81"
-32	2"	-32	2.81"

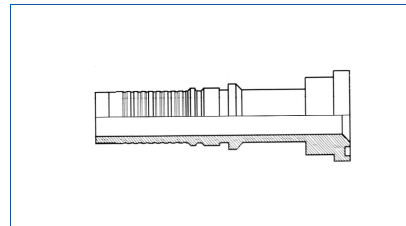

Code 61 Flange Interlock

Part Number
HFL3-12-12-SS
HFL3-12-16-SS
HFL3-16-16-SS
HFL3-16-20-SS
HFL3-20-20-SS
HFL3-20-24-SS
HFL3-24-24-SS
HFL3-24-32-SS
HFL3-32-32-SS

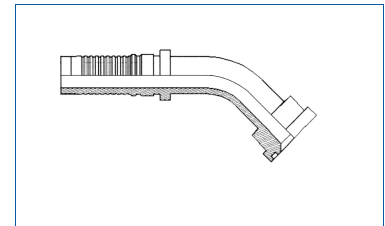

Code 61 Flange 45° Interlock

Part Number
HFL3-45-12-12-SS
HFL3-45-12-16-SS
HFL3-45-16-16-SS
HFL3-45-16-20-SS
HFL3-45-20-20-SS
HFL3-45-20-24-SS

Hose Size	Hose I.D.	Flange Size	Flange O.D.
-12	3/4	-12	1.50"
-12	3/4	-16	1.75"
-16	1"	-16	1.75"
-16	1"	-20	2.00"
-20	1-1/4	-20	2.00"

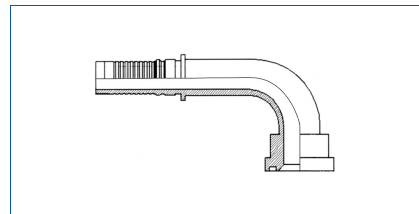

Code 61 Flange 90° Interlock

Part Number
HFL3-90-12-12-SS
HFL3-90-12-16-SS
HFL3-90-16-16-SS
HFL3-90-16-20-SS
HFL3-90-20-20-SS



316SS Interlock Code 62 Flange Hose Fittings

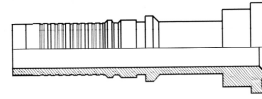

Code 62 Flange Interlock

Part Number

- HFL6-12-12-SS
- HFL6-12-16-SS
- HFL6-16-16-SS
- HFL6-16-20-SS
- HFL6-20-20-SS
- HFL6-20-24-SS
- HFL6-24-24-SS
- HFL6-24-32-SS
- HFL6-32-32-SS

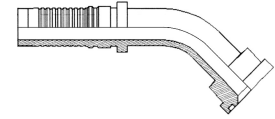

Code 62 Flange 45° Interlock

Part Number

- HFL6-45-12-12-SS
- HFL6-45-12-16-SS
- HFL6-45-16-16-SS
- HFL6-45-16-20-SS
- HFL6-45-20-20-SS
- HFL6-45-20-24-SS
- HFL6-45-24-24-SS
- HFL6-45-24-32-SS
- HFL6-45-32-32-SS

Hose Size	Hose I.D.	Flange Size	Flange O.D.
-12	3/4"	-12	1.63"
-12	3/4"	-16	1.88"
-16	1"	-16	1.88"
-16	1"	-20	2.13"
-20	1-1/4"	-20	2.13"
-20	1-1/4"	-24	2.50"
-24	1-1/2"	-24	2.50"
-24	1-1/2"	-32	3.13"
-32	2"	-32	3.13"

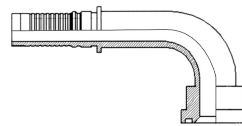

Code 62 Flange 90°

Model Number

- HFL3-90-12-12-SS
- HFL3-90-12-16-SS
- HFL3-90-16-16-SS
- HFL3-90-16-20-SS
- HFL3-90-20-20-SS
- HFL3-90-20-24-SS
- HFL3-90-24-24-SS
- HFL3-90-24-32-SS
- HFL3-90-32-32-SS

Hose Size	Hose I.D.	Flange Size	Flange O.D.
-12	3/4"	-12	1.63"
-12	3/4"	-16	1.88"
-16	1"	-16	1.88"
-16	1"	-20	2.13"
-20	1-1/4"	-20	2.13"
-20	1-1/4"	-24	2.50"
-24	1-1/2"	-24	2.50"
-24	1-1/2"	-32	3.13"
-32	2"	-32	3.13"